



TEACHER'S CARE ACADEMY

38/23, Vaigundaperumal Koil Street, Kanchipuram-1

Mobile : 95665 35080, 97862 69980

Help Line Numbers : 9360268118, 7639967359

UG TRB Zoology 2022-2023



UNIT - I (Volume-1) INVERTEBRATA

Your Success is Our Goal....

TEACHER'S CARE ACADEMY KANCHIPURAM



ZOOLOGY

UNIT - 1 (VOL - 1)

INVERTEBRATA



COMPETITIVE EXAM

FOR

UG -TRB-ZOOLOGY 2022 - 23

TEACHER'S CARE ACADEMY, KANCHIPURAM

TNPSC-TRB- COMPUTER SCIENCE -TET COACHING CENTER



**HEAD OFFICE: NO. 38/23, VAIGUNDA PERUMAL KOIL,
SANNATHI STREET, KANCHIPURAM – 1. CELL: 9566535080**

B.Off 2: 65C, Thillai Ngr (West), 4th Cross St, Trichy – 620018

B.Off 3: Vijiyaraghavachariar Memorial Hall (Opp to Sundar Lodge), Salem

Trichy : 76399 67359

Salem : 93602 68118

UG TRB - 2022 - 2023

ZOOLOGY

UNIT - 1 (VOL - 1)

INVERTEBRATA

SI.NO	CONTENTS	PAGE
1.1.	PRINCIPLES OF TAXONOMY	1
1.2	CLASSIFICATION AND NOMENCLATURE	1
1.3	BINOMIAL SYSTEM OF NOMENCLATURE	2
	1.3.1 Value	3
	1.3.2 Problems:	4
	1.3.3 Relationship to classification and taxonomy	5
	1.3.4 Rules Of Nomenclature	5
	1.3.5 Writing binomial names	7
1.4	SPECIES	8
1.5	CONCEPT OF SPECIES	10
	1.5.1 Typological species concept	13
	1.5.2 Nominalistic species concept	13
	1.5.3 Biological species concept	14
	1.5.4 Evolutionary species concept	15
1.6	International Code of Zoological Nomenclature	16
	1.6.1 Taxonomic Procedures:	17

1.7	Modern Trends in Taxonomy	17
2.	GENERAL CHARACTERS AND CLASSIFICATION UP TO ORDERS FROM PROTOZOA TO ECHINODERMATA	
2.1	CHARACTERISTICS OF INVERTIBRATES	19
2.2	CLASSIFICATION OF ANIMALIA KINGDOM:	20
3.	PHYLUM PROTOZOA	21
3.1.	Protozoa	21
	3.1.1 Protozoa: Definition, Characteristics, Classification and Types	21
	3.1.2 The major distinguishing characteristics of protozoa are given below:	21
	3.1.3 Classification of Protozoa	21
3.2	STUDY OF PARAMECIUM	34
	3.2.1 Locomotion in Paramecium	35
	3.2.2 Osmoregulation in paramecium:	35
	3.2.3 Nutrition:	36
	3.2.4 Digestion:	37
	3.2.5 Egestion:	37
	3.2.6 Reproduction in Paramecium	37
	3.2.7 Significance of Conjugation:-	39
3.3	PLASMIDIUM	41
	3.3.1. Geographical Distribution:	41
	3.3.2 Habitat:	41
	3.3.3 Morphology:	41
	3.3.4 Life cycle:	43
	3.3.5 Life cycle in mosquito:	45
	3.3.6 Complication of malaria	48
3.4	ENTAMOEBIA HISTOLYTICA	50
	3.4.1 Introduction:	50

	3.4.2 Distribution:	50
	3.4.3 Habitat:	50
	3.4.3.History:	51
	3.4.5 Mode of transmission:	52
	3.4.6 Morphology:	52
	3.4.7 Life cycle:	54
	3.4.8 Pathogenesis:	55
3.5	TRYPANOSOMA GAMBIANSI	59
	3.5.1 Distribution of Trypanosoma Gambiense	59
	3.5.2 Habit and Habitat of Trypanosoma Gambiense	59
	3.5.3 Structure of Trypanosoma Gambiense:	59
	3.5.4 Pellicle and Undulating Membrane:	60
	3.5.5 Life Cycle of Trypanosoma Gambiense	60
	3.5.6 Part of Life Cycle in Man:	61
	3.5.7 Part of Life Cycle in Tsetse Fly:	61
3.6	Leishmania donovoni	62
	3.6.1 Habitat of Leishmania Donovanii:	62
	3.6.2 Morphology of Leishmania Donovanii:	63
	3.6.3 Life-Cycle of Leishmania Donovanii:	65
4.	PHYLUM-PORIFERA	70
4.1	Introduction:-	70
4.2	Classification up to order level:	71
4.3	Reproduction of Leucosolenia	77
4.4	SPONGES	81
	4.4.1 History of Sponges:	81
	4.4.2. Definition of Sponges:	82
	4.4. 3. Origin of Sponges:	82
	4.4.4 General Characters of Sponges:	82
	4.4.5 Canal System in Sponges:	84
	4.4.6 The current of water takes the following route:	90

4.5.	Classification of Sponges:	92
4.6.	General Organisation of Sponges:	96
4.7	<i>Functions of Canal System:</i>	96
4.8.	Skeleton in Sponges:	97
4.9.	Reproduction in Sponges:	97
5.	PHYLUM COELENTERATA	102
5.1	Introduction	102
5.2	General characters and classification up to order level	102
	5.2.1-General Characters:	102
	5.2.2-Classification up to order level	103
5.3	Aurelia (A jelly-fish):	112
	5.3.1 Habit and Habitat:-	112
	5.3.2 Reproduction and Life History:	115
	5.3.3- Development of <i>Aurelia</i>	116
	5.3.4 Development of planula into Scyphistoma:	117
	5.3.5 Formation of Ephyra (Strobilation):-	118
	5.3.6 b- Polymorphism:-	120
5.4	CORALS AND CORAL REEFS:-	122
	5.4.1 Meaning of coral	122
	5.4.2 Structure of coral polyp	122
	5.4.3 Types of corals in different groups-polymorphism	123
	5.4.4 Kinds of coral reefs	124
5.5.	Economic importance of coral reefs:-	127
5.6	OBELIA GENERAL CHARACTERS	127
	5.6.1 Distribution	128
	5.6.2 Habit and Habitat	128
	5.6.3 External Morphology	128
	5.6.4 Polyp or hydranth (nutritive zooids):	128
	5.6.5 Blastostyle (reproductive zooids):	129
	5.6.6 Medusae:	130
5.7	OBELIA LIFE CYCLE	130

	5.7.1 Fertilization:	131
	5.7.2 Cleavage:	131
	5.7.3 Hydrula:	131
	5.7.4 Alternation of generation:	131
	5.7.5 Polyp:	131
	5.7.6 Medusa:	131
6.	PHYLUM- PLATYHELMINTHES	134
6.1	Introduction	134
6.2	GENERAL CHARACTERS OF PLATYHELMINTHES	135
6.3	Classification of Platyhelminthes	136
6.4	TYPE STUDY: FASCIOLA HEPATICA	148
	6.4.1 Habit and habitat:	148
	6.4.2 External morphology:	149
	6.4.3 -Structure of <i>Fasciola Hepatica</i> :	149
	6.4.4 Reproduction (Life cycle of <i>Fasciola hepatica</i>):-	150
	6.4.5 Infection to the final host:	154
	6.4.6-Parasitic Adaptation of <i>Fasciola</i> :-	156
6.5	TAENIA SOLIUM-THE TAPE WORM	157
	6.5.1 Geographical distribution:	157
	6.5.2 Habitat	158
	6.5.3 Morphology	158
	6.5.4 Life cycle	159
7.	PHYLUM- ASCAHELMINTHES	164
7.1	Introduction:	164
7.2	GENERAL CHARACTERS AND CLASSIFICATION:-	164
	7.2.1-GENERAL CHARACTERS:-	164
7.3	STUDY OF ASCARIS	173
	7.3.1 -Habit and Habitat:-	173
	7.3.2 structure	173
	7.3.3 Digestive System	176
	7.3.4 Respiratory System:-	177

	7.3.5 Excretory System:-	177
	7.3.6 Nervous System:-	178
	7.3.7 Reproductive System:-	179
	7.3.8 Life History of <i>Ascaris</i> :-	181
	7.3.9 Early development:-	182
	7.3.10 Infection-	182
8.	PHYLUM NEMATODA	187
8.1	Characteristics of phylum Nematoda	187
8.2	Parasitic Nematodes:	189
	8.2.1 Pinworm (<i>Enterobius vermicularis</i>):	189
	8.2.2 Intestinal roundworm (<i>Ascaris lumbricoides</i>):	190
8.3	<i>ANCYLOSTOMA DUODINALE</i>	191
	8.3.1 Habitat:	191
	8.3.2 Morphology:	192
	8.3.3 Life Cycle:	193
	8.3.4 Clinical Features:	193
8.4	<i>WUCHERERIA BANCROFTI</i>	195
	8.4.1 Organism Characteristics	195
	8.4.2 Life Cycle	196
	8.4.3 Pathogenesis and Clinical Features	197
8.5	<i>ENTEROBIUS VERMICULARIS</i>	199
	<i>8.5.1 Introduction</i>	199
	8.5.2 Organism Characteristics:	199
	8.5.3 Life Cycle	200
	8.5.4 Clinical Features	202

UNIT - I

1. INVERTEBRATA



1.1. PRINCIPLES OF TAXONOMY

Introduction

- The biodiversity in life, in terms of the number of living organisms, their variation and their distribution is quite amazing, which includes microorganisms, plants and animals. So far one million animal species have been described and named.

1.2 CLASSIFICATION AND NOMENCLATURE

- Since many identified and unidentified living forms are available, it certainly needs that every living organisms requires to be identified and categorized in a systematic order. The branch of biology dealing with this subject is called classification/ taxonomy/systematic. Absence of naming and classifying living organisms leads to many problems and worst confusion is being confounded, because of a single animal will be called in different names in different countries. Even within a single country it has several names in different
- regions, because of different languages and dialects. The common or vernacular names are notoriously at variance even within the confines of one continent and one language for example; the American big cat, *Felis concolor* has different common names in different parts of America, like panther, puma, mountain lion, deer killer, Indian devil etc., all these
- appellations apply to the one and only species *Felis concolor* (Puma). Another point is that some common names are quite misleading like; Silver fish, Jelly fish, Star fish, Cuttle fish etc. are not true fishes. All these problems can be resolved only when all living organisms are identified, classified and given scientific nomenclature. Classification is the curious outcome of human mind which aims to put things in an orderly way where similarity of one kind or another forms the basis of all classification.
- For animals similarity of structure (morphology) has traditionally been the basis upon which the classification has been build. With the enunciation of the evolutionary principles by Charles Darwin (1859) it is considered that all animals are related to each other by descent.

- Consequently this type of classification aims to give genealogical relationship to groups of animals under consideration. Earlier classifications are clearly based on anatomy; embryology geographical distribution and fossils (paleontology) to bridge gaps between the living and extinct forms (Hyman, 1959).
- Recently biochemistry, physiology, cytology and genetic studies have all begun to contribute towards classification of animals. But it still remains true that the most generally accepted classification of animals is firmly grounded in morphological (structure) similarity (Moody, 1978).
- This study involves naming of organisms (nomenclature) and systematic placing of them into groups (taxa) on the basis of certain relationship between organisms. Though many Greek scholars have studied living plants and animals, the work of Aristotle (384-322 B.C.) stands unique, because he characterized animals according to their actions, way of living, body parts and habitats therefore he is called the "Father of Biological Taxonomy".
- A more rational approach to the scientific method of classification, particularly on plants was carried out by John Ray (1627-1705). The most remarkable person to give an almost perfect 2-kingdom classification of plants and animals was the Swedish Naturalist, Carlous Linnaeus (1709-1778), rightly called the Father of Taxonomy for his outstanding contribution to systematics.
- He was the first to introduce the Binomial Nomenclature System, where every plant and animal will have two scientific names, the first word in the genus (where the first letter will be written in capital letter) and second word is the species (all words written in small letters. Example, *Pavo cristatus* (Peacock). He published his scheme of classification in the book entitled Systema Naturae in 1753. He strongly believed in the immutability or the fixation of the species.

1.3 BINOMIAL SYSTEM OF NOMENCLATURE

- The binomial system classifies organisms into groups at various hierarchic levels, on the basis of easily observable and shared morphological features like shape, number and position of limbs etc. in a descending order of group size. As the word binomial suggests, the name of a species is made up of two parts:

- one indicating the genus and indicating the species. Binomial nomenclature means “two part name” or “system of two part names”. The person who popularized this system for use was Swedish Botanist and physician Carlous Linnaeus (1707-1778) who tried to name all things in the natural world and gave every species that he knew a two-part name. This kind
- of naming had been used before Linnaeus about everybody did.
- In modern usage, the first letter of the first part of the name, the genus, is always capitalized in writing, while that of the second part is not, even when derived from a proper noun such as the name of a person or place similarly both parts are italicized when a binomial name occurs in normal text thus the binomial name of the human is *Homo sapiens* in zoology.
- “*Patella vulgata* Linnaeus, 1758”. The name “Linnaeus” tells the reader who it was that first published a description and name for this species of sea snail; 1758 is the date of the publication in which the original description can be found (in this case the 10th edition of the book *Systema Naturae*).
- “*Passer domesticus* (Linnaeus, 1758)” The original name given by Linnaeus was *Tringilla domestica*, the parentheses indicated that the species is now considered to belong in a different genus. The ICZN does not require that the name of the person who changed the genus be given, nor the date on which the change was made although nomenclature catalogs usually include such information.

1.3.1 Value

The value of binomial nomenclature system derives primarily from its economy, its widespread use, and the uniqueness and stability of names it generally favours:

Economy: compared to the polynomial system which it replaced, a binomial name is shorter and easier to remember. It corresponds to the widespread system of family name plus given name used to name people in many cultures.

Widespread use: The binomial system of nomenclature is governed by international codes and is used by biologists worldwide. A few binomials have also entered common speech such as *Homo sapiens*, *E. coli* and *Tyrannosaurus rex*.

Clarity: Binomial names avoid the confusion that can be created when attempting to use common names to refer to a species. Common names often differ from one country to another or even from one part of a country to another.

In English-speaking North America, a “robin” is *Turdus migratorius*. In English speaking parts of Europe, the “robin” is *Erithacus rubecula*. In contrast, the scientific name can be used all over the world, in all languages, avoiding confusion and difficulties of translation.

Uniqueness: Provided that taxonomists agree as to the limits of a species, it can have only one name that is correct under the appropriate nomenclature code, generally the earliest published if two or more names are accidentally assigned to a species. However, establishing that two names actually refer to the same species and then determining which has priority can be difficult, particularly if the species was named by biologist from different countries. Therefore a species may have more than one regularly used name; these names are synonyms.

Stability: Although stability is far from absolute, the procedures associated with establishing binomial names, such as the principle of priority, tend to favour stability. Similarly, if what were previously thought to be two distinct species are demoted to a lower rank, such as subspecies, where possible the second part of the binomial name is as third part of the new name. thus the *Tenerife robin* may be treated as a different species from the *European robin*, in which case its name is *Erithacus superbus* or as only a subspecies, in which case its name is *Erithacus rubecula superbus*. The *superbus* element of the name is constant since taxonomist can legitimacy disagree as to whether two genera or two species are distinct or not, more than one name can be in use. The only reason a specific epithet may need to be changed is if that by transferring it to a new genus it becomes a junior homonym of an older specific epithet for an older specific epithet for a different species in the same genus.

1.3.2 Problems:

Binomial nomenclature for species has the effect that when a species is moved from one genus to another not only is its genus name changed but sometimes its species name must be changed as well (because the name is already used in the new genus, or to agree in gender with the new genus) some biologist have argued for the combination of the genus name and specific epithet into a single unambiguous name, or for the use of uninominal (as used in nomenclature of ranks above species).

1.3.3 Relationship to classification and taxonomy

- Nomenclature (including binomial nomenclature) is not the same as classification, although the two are related. Classification is the ordering of items into groups based on similarities and/or differences; in biological classification species are one of the kinds of item to be classified. In principle, the names given to species could be completely independent of their classification. This is not the case for binomial names, since the first part of a binomial is the name of the genus into which the species is placed.
- Above the rank of genus, binomial nomenclature and classification are partly independent; for example, a species retains its binomial name if it better fits a different genus in the same or different family, or it is split from its old genus and placed in a newly created genus. The independence is only partial since the names of families and other higher taxa are usually based on genera.
- Taxonomy includes both nomenclature and classification. Its first stage (sometimes called alpha taxonomy) is concerned with finding, describing and naming species of living or fossil organisms. Binomial nomenclature is thus an important part of taxonomy as it is the system by which species are named. Taxonomists are also concerned with classification, including its principles, procedures and rules.

1.3.4 Derivation of binomial names

- A complete binomial name is always treated grammatically as if it were a phrase in the Latin language (hence the common use of the term “Latin name” for a binomial name). However, the two parts of a binomial name can each be derived from a number of sources, of which Latin is only one. These include:
- Latin, either classical or medieval thus both parts of the binomial name *Homo sapiens* are Latin words, meaning “wise” (sapiens), human/man (Homo).
- Classical Greek the genus *Rhododendron* was named by Linnaeus from the Greek word which is itself derived from rhodos, rose and Dendron tree. Greek words are often converted to a Latinized form. Thus coca (the plant from which cocaine is obtained) has the name *Erythroxylum coca*. Erythroxylum is derived from the Greek words erythros, red and xylon, wood. The Greek neuter ending –ov(-on) is often converted to the Latin neuter ending –um.

- Other language: The second part of the name *Erythroxylum coca* is derived from kuka, the name of the plant is Aymara and Quenchua. Since many dinosaur fossils were found in Mongolia, their names often use Mongolian words e.g. *Tarchia* from turki, meaning “brain” or *Saichania* meaning “beautiful one”.
- Name of people (often naturalist or biologists): the name *Magnolia campbellii* commemorates two people; Pierre Magnol , a French botanist, and Archibald Campbell, a doctor in British India. Name of the place: The lone star tick, *Amolyomna americanum*, is wide spread in the United States.
- Other sources: Some binomial names have been constructed from anagrams or other re-ordering of existing names. Thus the name of the Muilla is derived by reversing the name Allium. Name may also be derived from jokes or puns. For example, Ratcliffe described a number of species of Rhinoceros beetle, including *Cyclocephala nodanotheruon*.
- The first part of the name, which identifies the genus, must be a word which can be created as a Latin singular noun in the nominative case it must be unique within each kingdom, but can be repeated between kingdoms. Thus *Huia recurvata* is an extinct species of plant, found in fossils in Yunnan,
- China, whereas *Huia masonii* is a species of frog found in Java, Indonesia. The second part of a binomial may be an adjective. The adjective must agree with the genus in gender. Latin has three genders, masculine, feminine and neuter, shown by varying endings to nouns and adjectives. The house sparrow has the binomial name *Passer domesticus*. Here domesticus (Domestic) simply means “associated with the house” the sacred bamboo is *Nandina domestica* rather than *Nandina domesticus*, since tropical fruit langsung is a product of the plant *Lansium parasiticum* since lansium is neuter. Some common endings for Latin adjectives in these
- genders (masculine, feminine, neuter) are –us, -a, -um (as in the previous example of domesticus); -is, -e (e.g. tristis meaning sad), and –or, -us (e.g. minor, meaning smaller).
- The second part of a binomial may be a noun in the nominative case. An example is the binomial name of the lion, which is *Panthera leo* grammatically the noun is said to be in opposition to to the genus name and the two nouns do not have to agree in gender, in this case, *Panthera* is feminine and Leo is masculine.

- The second part of a binomial may be a noun in the genitive (possessive) case. The genitive case is constructed in a number of ways in Latin, depending on the declension of the noun.
- Common endings for masculine and neuter nouns are –ii or –i in the singular and –orum in the plural and for feminine nouns –ae in the singular and –arum in plural. The noun may be part of a person's name, often the surrounding as in the Tibetan antelope, *Pantholops hodgsonii*, the shrub *Magonolia hodgsonii* or the olive backed pipit *Anthus hodgsonii*. The meaning is “of the person named” so that magnolia hodgsonii means “Hodgson’s magnolia”. The –ii or –i endings show that in each case Hodgson was a man (not the same one); the person commemorated in the binomial name is not usually (if ever) the person who created the name; for example *Anthus hodgson*.



1.3.5 Writing binomial names

- By tradition, the binomial names of species are usually typeset in italics; for example, *Homo sapiens*. Generally the binomial should be printed in a font different from that used in the normal text; for example “several more *Homo sapiens* fossils were discovered”. When hand written, each part of a binomial name should be underlined; for example Homo sapiens.
- The first part of the binomial, the genus name, is always written with an initial capital letter. In current usage, the second part is never written with an initial capital.
- The binomial name should generally be written in full. The exception to this is when several species from the same genus are being listed or discussed in the same paper or report, or the same species is mentioned repeatedly; in which case the genus is written in full when it is first used, but may then be abbreviated to an initial (and a period/full stop) for example, a list of members of the genus can might be written as “*Canis lupus*, *C. aureus*, *C. simensis*”. In
- rare cases, this abbreviated form has spread to more general use; for example, the bacterium, *Escherichia coli* is often referred to as first *E. coli* and *Tyrannosaurus rex* is *T. rex* these two both often appearing in this form in popular writing even where the full genus name has not already been given.

- The abbreviation “spp.” (Plural) indicates “several species”. These abbreviations are not italicized (or underlined) for example “Canis sp.” Means an unspecified species of the genus Canis, while “Canis spp.” Means “two or more species of the genus Canis” (The abbreviations sp.” and spp.” Can easily be confused with the abbreviations “ssp.” (Zoology) or “subsp.” (Botany), plurals “sspp.” or “subssp” referring to one or more subspecies.
- The abbreviation “cf” (i.e. confer in latin) is used to compare individuals/taxa with known/described species conventions for use of the “cf” qualifier vary. In paleontology, it is typically used when the identification is not confirmed. For example “corvus cf nasicus” was used to indicate “a fossil bird similar to the Cuban crow but not certainly identified as this species”. In molecular systematic papers, “cf” may be used to indicate one or more undescribed

1.4 SPECIES

- In biology, a species (abbreviated sp., with the plural form species abbreviated spp.) is one of the basic units of biological classification and a taxonomic rank. The scientific system of naming ‘kinds’ of plants and animals revolves around the species level. The term ‘species’ is Latin for ‘kinds’. Since ancient time; philosophers and naturalists realized the necessity for a basic unit by which biodiversity on this planet may be described and estimated. But the development of a scientific theory of classification is relatively recent phenomenon.
- Simpson and Mayr have elaborated on the historical developments of taxonomy and its concepts early Greek Philosophers and Naturalist like Hippocrate, Plato and Aristotle also paid attention to biological classification Hippocrates (460- 377 B.C.) described types of animals, but there is no indication of useful classification in his work. Plato (427-347 B.C) was, in the words of Mayr, ‘the great antihero of evolution as he believed in essentialism which is also referred to as the theory of forms. Aristotle (384-322 B.C) was the father of biological classification.
- As far as evolution is concerned, he gave the idea of ladder of lip a series in which organisms could be arranged in the order of increasing complexity. He studied morphology of animals and also paid attention to embryology, habits and ecology. He emphasized that all the attributes of animals such as living actions habits and bodily parts may be taken into consideration in classification. His idea was also a kind of typological or essentialism as far as species is concerned.

- Linnaeus (1707-1778), a great taxonomist and sometimes called the 'father of taxonomy', adhered to downward classification. His thinking was that of an essentialist for whom species reflects the existence of fixed, unchangeable type (essence). He proposed binomial nomenclature. The typological definition of species based on the concept of Linnaeus is called essentialist species concept.
- Occam and his followers suggested that nature produces individuals and nothing more, and species has no actual existence in nature; it is only a mental concept. It is the basis of nominalistic species concept which was popular in France in the eighteenth century.
- A particular species concept is associated with a definition and definitions differ in different concept of species. It may be mentioned here that nearly all of the older definitions of the species, including those of Buffon, Lamarck and Cuvier refer to the morphological similarities of individuals of the same species.
- An entirely new species concept has begun to emerge in the seventeenth century. Ray believed in the morphological definition of species and his species characterization also contained the germ of biological species concept, which considers the reproductive relationship to be a principle species criterion. As early as 1760, Koelreuter mentioned that all the individuals which are able to interbreed and produce fertile progeny belong to the same species.
- Hundred years before Darwin, Buffon in his *Historie Naturelle* describes everything known in the natural world and believed in organic change but did not provide any mechanism to explain the evolutionary change. Although initially he believed in morphological species concept, Buffon prepared the way for biological species concept using sterility barrier (instead of morphological similarities) as species criterion later on, the biological species concept was
- developed due to contribution of Merrem, Voigt, Walsh and many other naturalist and taxonomist of the Nineteenth century.
- The biological species concept was clearly formulated by Jordan, Dobzhansky and Mayr. According to Mayr a species is a group of potentially or actually interbreeding natural population which are reproductively isolated from other such groups.
- However, Dobzhansky, being an evolutionary geneticist defined species as a reproductive community of sexually and cross-fertilizing individuals which share a common gene pool. The biological species concept is the most widely accepted, but it has certain difficulties in its application.

- Since biological species concept is applicable to non –dimensional situation, Simpson, faced with the problems of studying the evolutionary species concept in which a species is a lineage (an ancestral-descendent sequence of populations) evolving separately from others and with its own unitary evolutionary role and tendencies.
- Darwin explains the mechanism of evolution in his book Origin of species and his theory has two components: (i) descent with modification- all species living and extinct have descended from one or a few original form of pre-existing species, and (ii) natural selection as casual agent of evolutionary change. Darwin also recognized that species not only evolve but also divide. Darwin unquestionably had adopted a biological species conception the 1830s even though later he gave it up. He did not define species but appear to have a morphological concept of species which was central to his theory of natural selection.

1.5 CONCEPT OF SPECIES

- Species concepts originate in taxonomy in which species is the basic unit of classification according to the international commission of Zoological nomenclature. Survey of taxonomic literature shows that there are a large number of species concepts which have been suggested by naturalists, taxonomists and evolutionary biologists from time to time. There are more than 20 species concept which are listed below:

Agamospecies:

- Asexual lineages, uniparental organisms (parthenogens and apomicts) that cluster together in term of their genome, may be secondarily uniparental from biparental ancestors.

Biological Species:

- Mendelian population of sexually reproducing organisms, interbreeding natural populations isolated from other such groups, depending upon reproductive isolating mechanisms.

Cladistic Species:

- Set of organisms between speciation events or between speciation and extinction events, or a segment of a phylogenetic lineage between nodes.

Treatment:

- A single dose of Mebendazole or pyrantel pamoate, repeated after 10 to 14 days is effective.

Prevention and Control

- Health education on personal and community hygiene controls the spread of pinworm infections.

Question of the following:

1. Ascaris has _____ cells in the excretory system

- (a) Green gland
- (b) Flame
- (c) Nephron
- (d) Renette

2. Syncytial epidermis is found in _____.

- (a) Ascaris
- (b) Metaphire
- (c) Housefly
- (d) Periplaneta

3. _____ is known as a coelom derived from blastocoel

- (a) Enterocoel
- (b) Haemocoel
- (c) Pseudocoel
- (d) Schizocoel

4. This is the basis on which female Ascaris can be identified.

- (a) Two spicules found at the posterior end
- (b) Presence of postanal and preanal papillae
- (c) Straight posterior end
- (d) Common cloacal aperture



5. In Ascaris, the period of incubation outside the human body is

- (a) More than 30 days
- (b) 15-30 days
- (c) 8-14 days
- (d) 4-8 days

6. In the life cycle of Ascaris, the infective stage is
- (a) Third lava (b) Second larva
(c) Cyst (d) Fertilized egg
7. The body cavity of Ascaris is pseudocoel as
- (a) it is filled with pseudocoelomic fluid
(b) has very little parenchyma
(c) contains large cells termed pseudocoelocytes
(d) bound extremely by muscle layer and internally by intestines
8. Ascaris lumbricoides is found living in the intestine of
- (a) Pig (b) Homo sapiens
(c) Monkey (d) Goat and sheep
9. The process of morphological differentiating male and female sexes is known as
- (a) sexual dimorphism (b) polymorphism
(c) variation (d) none of the above
10. This has no alternate host
- (a) Plasmodium vivax (b) Tapeworm
(c) Fasciola hepatica (d) Ascaris lumbricoides





TEACHER'S CARE ACADEMY

38/23, Vaigundaperumal Koil Street, Kanchipuram-1

Mobile : 95665 35080, 97862 69980

Help Line Numbers : 9360268118,7639967359

UG TRB Zoology 2022-2023



UNIT - I (Volume-2)
INVERTEBRATA

Your Success is Our Goal....

TEACHER'S CARE ACADEMY, KANCHIPURAM

TNPSC-TRB- COMPUTER SCIENCE -TET COACHING CENTER



**HEAD OFFICE: NO. 38/23, VAIGUNDA PERUMAL KOIL,
SANNATHI STREET, KANCHIPURAM – 1. CELL: 9566535080**

B.Off 2: 65C, Thillai Ngr (West), 4th Cross St, Trichy – 620018

B.Off 3: Vijayaraghavachariar Memorial Hall (Opp to Sundar Lodge), Salem

Trichy : 76399 67359

Salem : 93602 68118

UG TRB - 2022 - 2023

ZOOLOGY

UNIT - 1 (VOL - 2)

INVERTEBRATA

SI.NO	CONTENTS	PAGE
9.	PHYLUM- ANNELIDA	1
9.1.	Introduction:-	1
9.2	General Characters and classification of Annelida	1
	9.2.1-General Characters of Annelida:-	1
	9.2.2:- Classification of Annelida:	2
9.3.	Introduction to Earthworm (Pheretima posthuma):	6
	9.3.1. Scientific Classification of Earthworm:	6
	9.3.2 Habit and habitat of Earthworm:	7
	9.3.3 External morphology of Earthworm	7
	9.3.4 Morphological feature of Earthworm:	9
9.4	METAMERISM AND PARASITIC ADAPTATIONS IN HIRUDINARIA	14
	9.4.1 HIRUDINARIA GRANULOSA (The Indian Cattle Leech)	14
	9.4.2 Ecology:-	14
	9.4.3 -Metamerism in Hirundinaria:-	15

	9.4.4 Significance of Metamerism:-	15
	9.4.5 Parasitic Adaptations in Hirundinaria:-	16
	9.4.6 Development:	17
9.5	TROCHOPHORE LARVA	18
	9.5.1 Historical Retrospect of Trochophore Larva:	18
	9.5.2 Structures of the Trochophore Larva (Loven's Larva of Polygordius):	18
	9.5.3 Structures of the Trochophore Larva in Different Classes:	20
9.6	Vermiculture:	24
	9.6.1 What is Vermiculture?	24
	9.6.2 Types of Earthworms for Vermiculture	25
	9.6.3 Mechanism of Digestion in Earthworms	26
	9.6.4 Application of Vermiculture	26
	9.6.5 Excretory System of Nephridia (Earthworm)!	27
	9.6.6 Economic importance of soil	31
	9.6.7 Important role of nematodes in Agriculture and health:	32
10.	PHYLUM ARTHROPODA	36
10.1	Introduction	36
10.2	GENERAL CHARACTERS	37
10.3	CLASSIFICATIONS	38
10.4	Zoological importance of Peripatus	54
	10.4.1 Habits and Habitat:	54
	10.4.2 External morphology:	55
	10.4.3 Affinities of Peripatus:	55
	10.4.4 Taxonomic Position:	58
10.5	Type study eg.Prawn or Penaeus	59

	10.5.1. External characters;	59
	10.5.2. Cephalothorax:	59
	10.5.3. Abdomen:	60
	10.5.4. Appendages:	60
	10.5.5. Digestive gland :	64
	10.5.6. Circulatory system	65
	10.5.7. Respiratory system	66
	10.5.8. Excretory System:	69
	10.5.9. Nervous system	69
	10.5.10 Sense organs	69
	10.5.11. Reproductive system	71
	10.5.12. Life history of Penaeus:	72
10.6	Larval forms of crustacean	72
	10.6.1 Nauplius	72
	10.6.2 Metanauplius	73
	10.6.3 Protozoaea	74
	10.6.4 Zoaea	74
	10.6.5 Cypris	75
	10.6.6 Mysis	76
	10.6.7. Megalopa	76
	10.6.8 Phyllosoma	77
	10.6.9 Alima	78
	10.6.10 Significance of larval forms of Crustacea	78
10.7	MOUTHPARTS OF INSECTS	79
	10.7.1 Mandibulate Mouthparts	79

	10.7.2 Modified Mandibulate Mouthparts 10.7.3 Haustellate Mouthparts	80
	10.7.4 Grasshoppers	81
	10.7.5 Ground Beetles	81
	10.7.6 Dragonfly Naiads	82
	10.7.7 Honey Bees	82
	10.7.8 Blow Flies	83
	10.7.9 Mosquitoes	83
	10.7.10 Moths or Butterflies	83
10.8	Economic Importance (Beneficial And Harmful) Of Insects	84
	10.8.1 Beneficial Insects	84
	10.8.2 Economic Importance of Insects	85
	10.8.3 Parasites and Predators:	91
10.9	SOCIAL LIFE OF INSECTS	98
	10.9.1 Introduction	98
	10.9.2. Order – Isoptera	99
	10.9.3. Order - Hymenoptera	104
	10.9.4. Order – Hemiptera	105
11.	PHYLUM MOLLUSCA	106
11.1.	INTRODUCTION	106
11.2	GENERAL CHARACTERS AND CLASSIFICATION	107
11.3	Study Notes on Pila Mollusca	117
	11.3.1 Introduction to Pila:	117
	11.3.2 Habit and Habitat of Pila:	117
	11.3.3 Structure of Pila:	118
11.4.	Excretory System of Pila:	128

11.5	Nervous System of Pila:	129
11.6	Reproductive System:	130
11.7.	Development of Pila:	132
11.8	LAMELLIDENS: DESCRIPTION AND EXTERNAL FEATURES	132
	11.8.1 Description of Lamellidens:	132
	11.8.2. External Features of Lamellidens:	132
	11.8.3. Microscopic Structure of Lamellidens:	134
	11.8.4. Muscles of Lamellidens:	135
	11.8.5. Locomotion in Lamellidens:	135
	11.8.6. Body Cavity of Lamellidens:	137
	11.8.7. Digestive System of Lamellidens:	137
	11.8.8 Respiratory System of Lamellidens:	139
	11.8.9. Circulatory System of Lamellidens:	140
	11.8.10. Heart and Pericardium:	141
	11.8.11. Excretory System of Lamellidens:	143
	11.8.12. Pericardial Gland of Lamellidens:	143
	11.8.13. Nervous System of Lamellidens:	143
	11.8.14. Receptors and Sense Organs in Lamellidens:	145
	11.8.15. Reproductive System in Lamellidens:	146
	11.8.16. Fertilization and Development in Lamellidens:	147
11.9	Foot of Phylum Mollusca:	149
	11.9 .1 Meaning and Origin of Foot:	149
	11.9.2 Origin:	149
	11.9.3 Innervation:	149
	11.9.4 Structure of Foot:	151
	11.9.5 Modification of Foot:	151

	11.9.6 Foot—as the burrowing organ:	153
11.10	TORSION IN GASTROPODA	157
	11.10.1 Definition:	157
	11.10.2 Conditions before Torsion:	158
	11.10.3 How Torsion Occurs:	159
	11.10.4 Cause and Significance of Lateral Torsion:	160
	11.10.5 Effect of Torsion and Shuttling of Pallial Complex:	160
	11.10.6 Views on the Significance of Torsion in Gastropods:	162
12.	PHYLUM ECHINODERMATA	166
12.1	INTRODUCTION	166
12.2	General characters	167
12.3	Classification	168
12.4	Asterias (Star fish)	174
	12.4.1 Habits and habitat:	174
	12.4.2 Structure	175
	12.4.3 Locomotion	176
	12.4.4 Mode of Feeding and Digestive system	177
	12.4.5 Reproduction	179
12.5	Class of Phylum Echinodermata Larval form	180
12.6	WATER VASCULAR SYSTEM OF STARFISH	183
	12.6.1. Introduction :-	183
	12.6.2 Function of Water Vascular System :-	185
	MORE IMPORTANT QUESTION	187

UNIT - 1 (VOL - 2)

9. PHYLUM- ANNELIDA

9.1. Introduction:-

- Name of phylum Annelida was first coined by Lamarck (1801) for the higher segmented
- worms (Gr., annulus - little ring + eidos - form). Annelids are elongated, bilaterally symmetrical and highly organized animals, in which the organs have grouped in to definite systems.
- Appearance of metamerism represents their greatest advancement, so that they are called segmented worms in order to distinguish them from flatworms (Platyhelminthes) and roundworms (Nematodes) which are not segmented. Their paired appendages, when present, are never jointed. Their coelom, nephridia and cephalization are better developed than those of the un-segmented worms.
- They are the first animals to have a closed vascular system. Nervous system is fundamentally similar to that of Arthropoda and embryology is not much different from that of mollusca.

9.2 General Characters and classification of Annelida

9.2.1-General Characters of Annelida:-

Mostly aquatic, some terrestrial.

- Burrowing or tubicolous.
- Some commensal and parasitic.
- Body elongated, bilaterally symmetrical, triploblastic, truly coelomate and metamericly segmented into similar metamers.
- Epidermis of a single layer of columnar epithelial cells, covered externally by a thin cuticle.
- Body wall dermo-muscular.
- Outer muscle fibres circular, longitudinal.
- Locomotory organs are segmentally repeated chitinous bristles, called setae or chaetae, embedded in skin. May be borne by lateral fleshy appendages or parapodia.

- Coelom, true, schizocoelous. Mostly well developed except in leeches.
- Usually divided into compartments by transverse septa.
- Coelomic fluid with cells or corpuscles.
- Digestive system straight and complete.
- Digestion entirely extracellular.
- Blood vascular system is closed.
- Respiratory pigments either haemoglobin or erythrocrurin dissolved in blood plasma.
- Respiration by moist skin or gills of parapodia and head.
- Excretory system consisting of metamerically disposed coiled tubes, called nephridia.
- Nervous system with a pair of cerebral ganglia (brain) and a double ventral nerve cord bearing ganglia and lateral nerves in each segment.
- Sensory organs include tactile organs, taste buds, statocysts, photoreceptor cells and sometimes eyes with lenses in some.
- Hermaphroditic or sexes separate, cleavage pattern spiral and determinate.
- Larva, when present, is a trochophore.
- Regeneration is common.

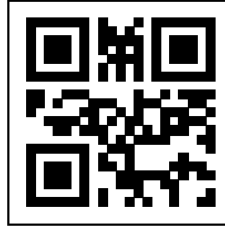

9.2.2:- Classification of Annelida:

- Modern classification of phylum Annelida was proposed by Fauchold (1977) and Parker (1980). About 8,700 known species of annelid are divided into four main classes, primarily on the basis of the presence or absence of parapodia, setae, metamers, and other morphological features.

A. Class – Polychaeta (Gr., poly- many + chaite- hair)

- Chiefly marine, some in fresh water.
- Segmentation internal and external.
- Head distinct with eyes, palps and tentacles.
- Setae numerous, on lateral parapodia.

- Clitellum absent.
- Sexes separate.
- Gonads temporary and in many segments.
- Trochophore larva present.
- Polychaetes are divided into two subclasses, Errantia and Sedentaria (Fauvel, 1959).
- However, according to Dab (1963), this subdivision is artificial and not a natural one.

1. Subclass – Errantia

Free-swimming, crawling, burrowing or tube-dwelling and predatory polychaetes.

- Segments numerous and similar, except for head and anal region.
1. Prostomium distinct with sensory structures.
 2. Parapodia with acicula and compound setae.
 3. Pharynx protrusible, enlarged and usually with jaws and teeth.

Examples: Aphrodite (sea mouse, Fig.1), Polynoe (Fig.2), Phyllodoce, Tomopteris, Syllis, Nereis, Glycera, Eunice, Diopatra, Histiobdella.

2. Subclass - Sedentaria

- Sedentary polychaetes living in burrows or tubes.
- Body made of two or more regions, with dissimilar segments and parapodia.
- Prostomium small.
- No acicula and compound setae.
- Pharynx without jaws and teeth.

Examples: Chaetopterus (Fig.3), Arenicola (Fig.4), Owenia, Sabella, Sabellaria, Terebella Amphitrite Pomatoceros, Spirorbis, Serpula.

2. Class - Oligochaeta (Gr., oligos- few + chaite - hair)

- Mostly terrestrial, some in fresh water.
- Segmentation internal and external.
- Head distinct, without sensory organs.

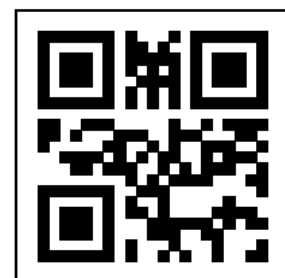

- Setae few, embedded in skin.
- Parapodia absent.
- Glandular clitellum present for cocoon formation.
- Hermaphroditic.
- Testes anterior to ovaries.
- Fertilization external (in cocoon); development direct, no larval stages.

1. Order - Plesiopora plesiothecata

- Mostly aquatic.
- Male gonopores on segment immediately following that which contains testes.
- Spermathecae in the testes-containing segments, or nearby.

Examples: Aelosoma, Nais, Dero, Chaetogaster, Tubifex

2. Order - Plesiopora prosothecata

- Spermathecae far anteriorly to the segment containing testes.

Examples: Enchytraeus.

3. Order - Prosopora

- Mostly aquatic.
- Male gonopores on the same segment containing testes, or on segment containing the second pair of testes.

Example: Branchiobdella (parasitic).

4. Order - Opisthopora

- Mostly terrestrial earthworms.
- Male gonopores some distance behind the testes-containing segments.

Examples: Lumbricus (Fig.8), Eisenia, Pheretima, Megascolex, Allolobophora, Dendrobaena.

3. Class – Hirudinea (L., hirudo- leech)

- Freshwater, marine or terrestrial.

- Generally ectoparasitic, blood-sucking and carnivorous.
- Body with fixed number of segments (33).
- Each segment subdivided externally into annuli.
- Segmentation external without internal septa.
- Parapodia and setae absent.
- Both anterior and posterior ends of body with suckers.
- Coelom much reduced due to its filling by botryoidal tissue, and forms haemocoelomic sinuses.
- Hermaphroditic with one male and one female gonopore.
- Fertilization internal.
- Development in cocoons, direct without larval stages.

1. Order - Acanthobdellida

- Primitive without anterior suckers, proboscis and jaws.
- Setae present in 5 anterior segments.
- Coelom with compartments.

Example: A single Russian genus and species (Acanthobdella) parasitic on salmon.

2. Order - Rhynchobdellida

- Only aquatic leeches, ectoparasitic.
- A protrusible proboscis with no jaws.
- Coelom without compartments.
- Bloodvascular system separated from coelomic sinuses Blood colourless.

3. Order - Gnathobdellida

- Aquatic or terrestrial.
- Ectoparasitic blood-sucking leeches.
- Pharynx non-reversible with 3 pairs of jaws.

Examples: Hirudo, Hirudinaria, Haemadipsa.

4. Order - Pharyngobdellida

- Terrestrial and aquatic.

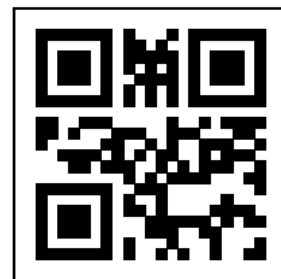

- Some predaceous.
- Pharynx non-protrusible.
- No teeth but one or two style may be present.

Examples: Erpobdella, Dina.

4. Class - Archiannelida (Gr., arch- First)

- About one dozen genera of small, marine worms of unknown affinities.
- Segmentation chiefly internal.
- No parapodia and setae.
- Sexes usually separate.
- Usually trochophore larva.

Example: Polygordius, Dinophilus, protodrilus.

9.3. Introduction to Earthworm (Pheretima posthuma):

- The life span of earthworm is 3-10 years. An adult worm measures about 15-30 cm in length and is dark brown in colour due to the presence of a pigment porphyrin in its skin. The body is made of 100 to 120 segments, of which the first segment is divided into an anterior prostomium and posterior ring-like peristomium.

9.3.1. Scientific Classification of Earthworm:

Kingdom: Animalia

Phylum: Annelida

Class: Oligochaeta

Order: Opisthopora

Genus: Pheretima

Species: posthuma

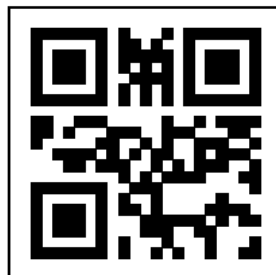

9.3.2 Habit and habitat of Earthworm:

- Earthworms are segmented invertebrates, that are reddish brown in color.
- Being terrestrial in nature, it mostly inhabits the upper layer of the moist soil.
- It is also fossorial in nature, i.e. it burrows the soil and lives inside burrows made in moist soil.
- They feed on organic matter present in the soil and the undigested substances are expelled in the form of castings.
- The holes of earthworm can be recognized by the presence of castings termed as pellets.
- Earthworms are generally known as farmer's friend as the fecal deposits of earthworm helps to increase the fertility of soil and burrowing aids in adequate aeration of the soil.
- They are distributed globally and are ranged from sea level to altitude of 3000m.
- However, it is more abundant during the rainy season.
- The earthworm is nocturnal in nature, meaning it stays active at night.

9.3.3 External morphology of Earthworm

Mouth:

- It is crescentic in shape and lies on the ventral side of a first segment i.e. peristomium.
- Dorsal to it, prostomium is present.

Anus:

- It is present on the anal segment, i.e. the last segment.
- The anal segment lies in the vertical slit like aperture.
- Its size is small.

Male genital pore:

- The male genital pores lie ventrolaterally on 18th segment.

- They are a pair of crescentic apertures.
- The male reproductive bodies get discharged through these pores.

Female genital pore:

- A single, minute female genital pore is present in the 14th segment mid-ventrally.
- The female reproductive bodies are discharged through it.

Dorsal pores:

- They are present after 12 segments except the last segment.
- Coelomic fluid oozes out from this pore that lubricates the surface of body.

Nephridiopores:

- They are present in all segments except first two segments.
- In a body wall, several minute nephridiopores are present.
- The apertures of integumentary nephridia represent the nephridiopores.
- The metabolic wastes are discharged out of the body through these pores.

Spermathecal pores:

- They are situated ventrolaterally.
- They are through intersegmental in nature found in segment 5/6, 6/7, 7/8, 8/9.
- The spermatozoa enter the spermatheca through these pores.
- During copulation, these pores store sperm.

Genital papillae:

- The genital papillae are the most prominent structures present in the ventral side of the body of earthworm.
- It is a conical elevation found in segment 17 and 19 a pair each.
- These papillae aids in temporary attachment in course of reproduction.

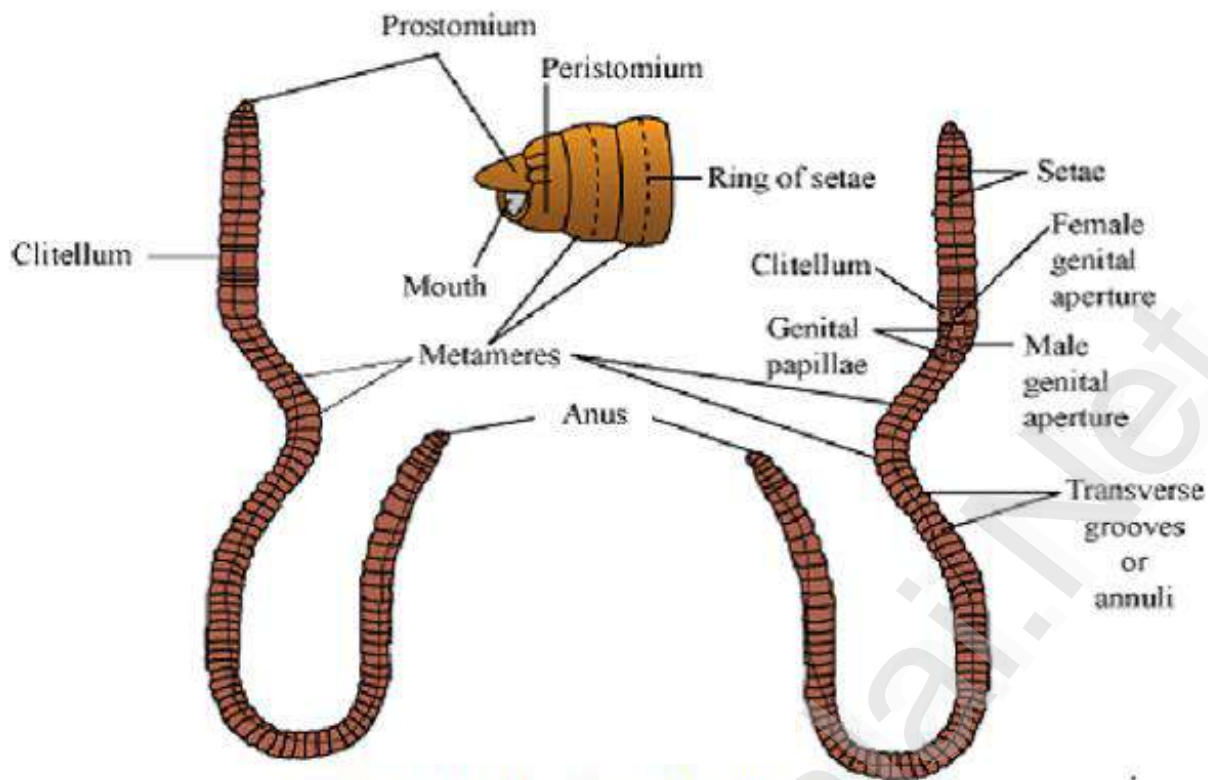

Figure: External Features of Earthworm

9.3.4 Morphological feature of Earthworm:

i. Shape and size:

- The body of earthworm is long and cylindrical almost pointed at both the anterior and posterior end.
- It shows bilateral symmetry.
- The anterior end is tapering and the posterior end is more or less blunt.
- The length of earthworm is about 15cm and the width varies from 3-5mm.

ii. Coloration:

- The body appears reddish brown in color.
- The dorsal region is darker in comparison to other regions, and has median dark line.
- The dark coloration is because of the deposition of porphyrin pigment.
- The dorsal blood vessel forms the median dark line.

iii. Segmentation:

- The body is metamerically segmented, seen with 100-120 similar segments called metameres.

- Both the external and internal segmentation is present.
- The circular groove called annuli forms the external segmentation.
- The muscular partition termed as septa forms the internal segmentation.
- The body can be divided into dorsal, ventral, anterior and posterior regions.
- The anterior region lies in close proximity to the clitellum whereas the posterior region lies far from the clitellum.
- In the anterior end, the mouth and the prostomium is present.
- The prostomium is a lobe that aids as a covering for the mouth and helps in burrowing by its wedge like structure.
- Prostomium functions as sensory part.
- The first body segment is termed as the peristomium that possess the mouth.

iv. Setae:

- Setae are S-shaped chitinous structures and are yellow in color.
- Their number ranges from 80-120 per segment.
- Setae are responsible for locomotion and are present in all segments except the first, last and clitellar segments.
- It is arranged in perichaetine order, i.e. in a ring/circle.
- In the setal sac of the body wall, setae are embedded.
- The setae are operated by 2 sets of muscles:
- A pair of protractor muscles (contraction results in extension of sac)
- Single retractor muscle (contraction results in withdrawal of setae)
- Ventral setae are used for crawling on the ground and lateral setae are used while moving in burrows.

v. Clitellum:

- The clitellum is thick girdle like structure formed by body wall.
- It is glandular in nature and pinkish in color.
- It is present in 14th, 15th, and 16th segments.
- It secretes mucus, albumen and during breeding season, it secretes cocoon.

MORE IMPORTANT QUESTION:

1. *Asterias* belong to:

(a) Echinoidea	(b) Asteroidea
(c) Ophiuroidea	(d) Holothuroidea
2. Common name of *Asterias*:

(a) Brittle star	(b) Star fish	(c) Sea pentagon	(d) Basket star
------------------	---------------	------------------	-----------------
3. Locomotory organs of starfish:

(a) Polian vesicles	(b) Podia	(c) Both	(d) None
---------------------	-----------	----------	----------
4. Characteristic feature of echinoderm:

(a) Haemal system	(b) Water vascular or ambulacral system
(c) Both	(d) None
5. Larval stage in life history of starfish:

(a) Dipleurula	(b) Bipinnaria
(c) Brachiolaria	(d) All of the above
6. The eggs of *Asterias* are:

(a) Macrolecithal	(b) Microlecithal
(c) Megalecithal	(d) Oligolecithal
7. Excretory products:

(a) Urea and creatine	(b) Ammonia
(c) Urea	(d) Uric acid
8. Which of the following phyla is found only in sea water?

(a) Annelida	(b) Arthropoda
(c) Mollusca	(d) Echinodermata
9. Most fragile arms are of:

(a) Star fish	(b) Sea urchin	(c) Brittle star	(d) none
---------------	----------------	------------------	----------
10. Tube feet are locomotory in function and also perform additional:

(a) Excretory function	(b) Feeding function
(c) Protective function	(d) All the above

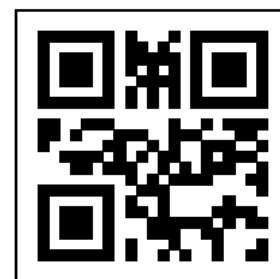

11. Pick the right sequence of taxonomic categories
- (a) division-class-family-tribe-order-genus-species
 - (b) division-class-family-order-tribe-genus-species
 - (c) division-class-order-family-tribe-genus-species
 - (d) division-order-class-family-genus-tribe-species
12. The binomial nomenclature of peacock is _____
- a) *Pavo cristatus*
 - b) *Corvus corone*
 - c) *Haliaeetus leucocephalus*
 - d) *Barnardius zonarius*
13. Pick the incorrect statement.
- a) Binomial nomenclature has two parts namely generic epithet and specific epithet and also some descriptive information along with them
 - b) Binomial nomenclature helps you to identify the relationship between animals
 - c) The rules for binomial nomenclature are set by IUCN
 - d) Binomial nomenclature is introduced in order to avoid ambiguity that arises due to different names for a same animal in different languages
14. Which among the following is not a rule for writing binomial nomenclature?
- a) The generic epithet should start with capital letter and specific epithet should start with small letter with a hyphen separating them
 - b) All the words in the binomial nomenclature should either be Latinized or should be derived from Latin
 - c) Binomial nomenclature may contain description about the organism
 - d) The first part of the binomial nomenclature contains the generic name and the second part contains the specific epithet
15. Which among the following statements are correct?
- a) All the biological names have their origin in Latin
 - b) The first word in a biological name represents the species and the next represents genus
 - c) *Canis lupus familiaris* is the binomial nomenclature of a dog
 - d) *Panthera Tigris* is the binomial nomenclature of a tiger

16. Main function of contractile vacuole is ____
- (a) Nutrition (b) Excretion
(c) Osmoregulation (d) Locomotion
17. Digestion in protozoans is ____
- (a) Intercellular (b) Intracellular (c) Extracellular (d) All of these
18. Cytopyge is found in
- (a) Amoeba (b) Paramecium
(c) Euglena (d) Trypanosoma.
19. Correct sequence of evolution of canal system in sponges is
- (a) *Sycon*-Ascon-Leucon (b) Ascon-*Sycon*-Leucon
(c) *Sycon*-Leucon-Ascon (d) Leucon-Ascon-*Sycon*.
20. Members of Phylum Porifera are
- (a) Mostly marine animals, few being freshwater
(b) Exclusively marine animals
(c) Mostly freshwater animals few being marine
(d) exclusively freshwater animals
21. Protothen is a ____
- (a) Nutritive secretion (b) Skeleton rudiments
(c) Larvae (d) Exoskeleton.
22. Most important example of barrier reef is
- (a) Florida keys (b) West Indies
(c) Great Barrier Reef (d) None
23. During its life cycle, *Fasciola hepatica* infects its intermediate host and primary host at the following larval stages respectively
- (a) Redia and miracidium (b) Cercaria and redia
(c) Metacercaria and cercaria (d) Miracidium and metacercaria.
24. In *fasciola*, miracidium develops into the next stage inside
- (a) *Bulinus* (b) *Limnaea truncatula*
(c) *Pila globosa* (d) *Planorbis*





TEACHER'S CARE ACADEMY

38/23, Vaigundaperumal Koil Street, Kanchipuram-1

Mobile : 95665 35080, 97862 69980

Help Line Numbers : 9360268118, 7639967359

UG TRB Zoology 2022-2023



UNIT - III CELL AND MOLECULAR BIOLOGY

Your Success is Our Goal....

TEACHER'S CARE ACADEMY KANCHIPURAM



ZOOLOGY

UNIT - 3

CELL AND MOLECULAR BIOLOGY

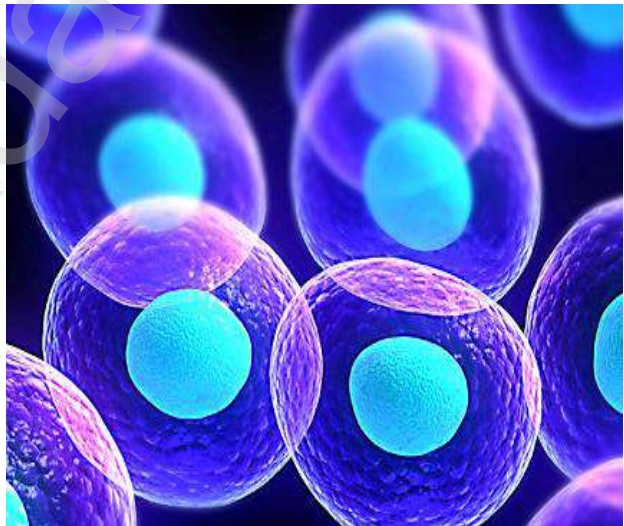

COMPETITIVE EXAM

FOR

UG -TRB-ZOOLOGY 2022 - 23

TEACHER'S CARE ACADEMY, KANCHIPURAM

TNPSC-TRB- COMPUTER SCIENCE -TET COACHING CENTER



HEAD OFFICE: NO. 38/23, VAIGUNDA PERUMAL KOIL,
SANNATHI STREET, KANCHIPURAM – 1. CELL: 9566535080

B.Off 2: 65C, Thillai Ngr(West), 4th Cross St, Trichy – 620018

B.Off 3: Vijiyaraghavachariar Memorial Hall(Opp to Sundar Lodge), Salem

Trichy : 76399 67359

Salem : 93602 68118

UG – TRB – 2022 - 23

ZOOLOGY

UNIT - III

CELL AND MOLECULAR BIOLOGY

INDEX

S.No	CONTENTS	PAGE
	1. MICROSCOPE	1
1.1	INTRODUCTION	1
1.2	TYPE OF MICROSCOPE	1
1.2.1	SIMPLE MICROSCOPE:	2
1.2.2	THE COMPOUND LIGHT MICROSCOPE	2
1.2.3	DARK-FIELD MICROSCOPE	8
1.2.4	Phase-Contrast Microscope	9
1.2.5	FLUORESCENCE MICROSCOPE	11

1.2.6	ELECTRON MICROSCOPY	12
	2. CYTOLOGICAL TECHNIQUES	20
2.1	FIXATION OF CYTOLOGY SPECIMENS	20
2.2	CYTOLOGICAL FIXATIVES	21
2.3	STAINING METHODS IN CYTOLOGY	24
2.3.1	PAPANICOLAOU STAINING METHOD	24
2.3.2	RAPID PAPANICOLAOU STAINING	28
	3. CENTRIFUGATION- PRINCIPLE, TYPES AND APPLICATIONS	31
3.1	INTRODUCTION	31
3.2	PRINCIPLE OF CENTRIFUGATION	32
3.3	TYPES OF CENTRIFUGE	32
3.3.1	LOW-SPEED CENTRIFUGE	32
3.3.2	HIGH-SPEED CENTRIFUGES	33
3.3.3	ULTRACENTRIFUGES	33
3.3.4	CENTRIFUGAL FORCE FORMULA	40
3.3.5	PRINCIPLE OF CENTRIFUGAL FORCE	40
3.3.6	HOW IS CENTRIFUGAL FORCE CALCULATED?	41
3.3.7	APPLICATIONS OF CENTRIFUGAL FORCE	41

3.3.8	SEDIMENTATION RATE AND SEDIMENTATION COEFFICIENT:	42
3.3.9	THE ANALYTICAL ULTRACENTRIFUGE:	43
	4.CELL BIOLOGY	46
4.1	INTRODUCTION	46
4.1.1	CELL AS A BASIC UNIT	46
4.1.2	CLASSIFICATION OF CELL TYPES	47
4.2	HISTORY OF CELL BIOLOGY	48
4.3	CELL DOCTRINE:	50
4.3.1	CONCEPT OF A MODERN CELL:	51
4.4	CELL THEORY	51
4.4.1	MODERN CELL THEORY:	52
4.4.2	EXCEPTION TO CELL THEORY	52
4.4.3	PROTOPLASM THEORY	52
	5. ULTRA STRUCTURE OF PROKARYOTES	54
5.1	INTRODUCTION	54
5.2	SIZE OF BACTERIA:	54
5.3	FORMS OF BACTERIA	54
5.4	STRUCTURE OF CAPSULE:	55

5.5	CELL WALL:	56
5.6	MESOSOMES (OR) CHONDRIODS):	58
5.7	FLAGELLA:	58
5.8	FIMBRIAE OR PILLI:	61
5.9	CYTOPLASM:	61
5.10	MYCOPLASMA OR PPLO:	63
5.11	ESCHERICHIA COLI:	64
	6. EUKARYOTIC CELL	66
6.1	INTRODUCTION	66
6.2	CYTOPLASMIC MEMBRANE	66
6.3	CELL WALL	68
6.4	ENDOPLASMIC RETICULUM (ER)	69
6.5	GOLGI APPARATUS	70
6.6	RIBOSOMES	70
6.7	MITOCHONDRIA	71
6.8	LYSOSOMES	72
6.9	NUCLEUS	72
6.10	CYTOSKELETON	73
6.11	CILIA AND FLAGELLA	74
6.12	PLASTIDS	74

	7. ANIMAL CELL- ULTRA STRUCTURE AND FUNCTIONS	75
7.1	ANIMAL CELL SIZE AND SHAPE	76
7.2	LIST OF ANIMAL CELL ORGANELLES	77
7.3	ANIMAL CELL ORGANELLES	77
	8. CELL MEMBRANE	99
8.1	STRUCTURE OF CELL MEMBRANE	99
8.2	CHEMICAL NATURE OF MEMBRANES:	100
8.3	LAMELLAR MODELS: GORTER AND GRENDDEL'S MEMBRANE THEORY (1925)	100
8.4	PROTEIN-LIPID-PROTEIN HYPOTHESIS (SANDWICH MODELS):	101
8.5	FLUID MOSAIC MODEL	103
8.5.1	PHOSPHOLIPIDS	104
8.5.2	PROTEINS	106
8.5.3	CARBOHYDRATES	107
8.5.4	MEMBRANE FLUIDITY	107
8.5.5	COMPONENTS OF THE PLASMA MEMBRANE	108
8.6	ROBERTSON'S UNIT MEMBRANE	109
8.7	DANIELLI DAVSON MODEL OF PLASMA MEMBRANE	110

8.7.1	LIPID BILAYER	110
8.7.2	FEATURES OF THE DAVSON-DANIELLI MODEL	111
8.7.3	SUPPORT OF DAVSON-DANIELLI MODEL	112
8.8	PLASMA MEMBRANE FUNCTIONS	112
	9. CELL ORGANELLES-ENDOPLASMIC RETICULUM:	117
9.1	9.1 STRUCTURE:	118
9.2	GRANULAR OR ROUGH ENDOPLASMIC RETICULUM:	120
9.3	AGRANULAR OR SMOOTH ENDOPLASMIC RETICULUM:	121
9.4	FUNCTIONS OF ENDOPLASMIC RETICULUM:	122
	10. RIBOSOME'S	125
10.1	INTRODUCTION	125
10.2	STRUCTURE OF RIBOSOME:-	125
10.3	TYPES OF RIBOSOMES	126
10.4	FUNCTIONS OF RIBOSOME	128
10.5	IMPORTANCE OF RIBOSOME	128
	11. GOLGI COMPLEX: -	130
11.1	INTRODUCTION	130
11.2	STRUCTURE OF GOLGI BODIES: -	130
11.3	FUNCTIONS OF GOLGI BODIES: -	131

	12. LYSOSOME	134
12.1	INTRODUCTION: -	134
12.2	GENERAL HISTORY OF LYSOSOMES: -	134
12.3	STRUCTURE OF LYSOSOMES: -	135
12.4	KINDS OF LYSOSOMES	135
12.4.1	CHEMICAL NATURE OF LYSOSOMES: -	136
12.4.2	FUNCTIONS OF LYSOSOMES	137
12.4.3	IMPORTANCE OF LYSOSOMES	138
	13. CENTRIOLE: -	139
13.1	INTRODUCTION	139
13.2	STRUCTURE OF CENTRIOLE: -	139
13.3	CHEMICAL COMPOSITION: -	142
13.4	FUNCTIONS OF CENTRIOLE: -	142
13.5	IMPORTANCE OF CENTRIOLE: -	142
	14.MITOCHONDRIA	144
14.1	INTRODUCTION	144
14.2	STRUCTURE OF MITOCHONDRIA	144
14.2.1	MORPHOLOGY OF MITOCHONDRIA	144

14.3	ULTRA STRUCTURE OF MITOCHONDRIA	145
14.4	FUNCTIONS OF MITOCHONDRIA: -	149
	15. MICROTUBULES	153
15.1	INTRODUCTION	153
15.2	STRUCTURE OF MICROTUBULE: -	154
15.2.1	CHEMICAL COMPOSITION: -	154
15.2.2	FUNCTIONS OF MICROTUBULES: -	155
15.2.3	IMPORTANCE OF MICROTUBULES: -	155
	16. NUCLEUS	157
16.1	INTRODUCTION: -	157
16.2	GENERAL HISTORY OF NUCLEUS: -	158
16.3	STRUCTURE OF NUCLEUS:-	158
16.3.1	CHEMICAL COMPOSITION:	159
16.3.2	NUCLEAR ENVELOPE: -	159
16.3.3	NUCLEAR PORES:	160
16.3.4	NUCLEOPLASM: -	161
16.3.5	NUCLEAR MATRIX: -	162
16.3.6	CHROMATIN: -	162
16.4	NUCLEOSOME	163
16.5	NUCLEOLUS (LITTLE NUCLEUS):-	164

	17. CHROMOSOMES	167
17.1	INTRODUCTION: -	167
17.2	GENERAL HISTORY OF CHROMOSOMES	167
17.3	MORPHOLOGY OF CHROMOSOMES	198
17.4	TYPES OF CHROMOSOMES BASED ON CENTROMERE POSITION	171
17.5	FUNCTIONS OF CHROMOSOMES: -	171
	18. HETEROCHROMATIN AND EUCHROMATIN	173
	19.SPECIALIZED CHROMOSOMES	175
19.1	GIANT CHROMOSOMES: -	175
19.1.1	POLYTENE CHROMOSOMES: -	175
19.1.2	LAMPBRUSH CHROMOSOMES	177
	20. CELL DIVISION	179
20.1	CELL CYCLE: -	180
20.1.1	PHASES OF CELL CYCLE: -	180
20.1.2	CONTROL OF CELL CYCLE: -	182
20.2	MITOSIS: -	184
20.2.1	STAGES OF MITOSIS IN ANIMAL CELLS	185
20.2.2	SIGNIFICANCE OF MITOSIS: -	189

20.3	MEIOSIS: -	189
20.3.1	FIRST MEIOTIC DIVISION OR MEIOSIS-I:-	191
20.3.2	FIRST MEIOTIC DIVISION OR MEIOSIS-II	195
20.3.3	CYTOKINESIS: -	197
	21. CANCER	202
21.1	TYPES OF CANCER	202
21.2	GENETIC REARRANGEMENTS IN PROGENITOR CELLS	203
21.3	ONCOGENES – DEFINITION	206
21.4	VIRAL ONCOGENES	207
21.5	CELLULAR ONCOGENES	209
21.6	PROTO-ONCOGENES	211
21.7	ACTIVATION OF PROTO ONCOGENE	212
21.8	VIRUS INDUCED CANCER	214
21.9	DNA VIRUSES	215
21.10	RNA VIRUSES	215
21.11	METASTASIS – DEFINITION	216
21.12	INTERACTION OF CANCER CELLS WITH NORMAL CELLS	219
21.13	DISTINGUISH CANCER & NORMAL CELLS	220

	22. GENE RESPONSIBLE IN AGING	226
22.1	GENETIC THEORY OF AGING	226
	23. STEM CELLS	232
23.1	ADULT STEM CELL DIFFERENTIATION	236
23.2	ADULT STEM CELL PLASTICITY AND TRANS DIFFERENTIATION	237
23.3	USE OF STEM CELLS TO REPAIR DAMAGED TISSUES	238
	24. NUCLEIC ACIDS-STRUCTURE AND FUNCTIONS OF DNA	242
24.1	WHAT IS DNA?	242
24.2	DNA STRUCTURE	242
24.3	CHARGAFF'S RULE	245
24.4	FORMS OF DNA	245
24.4.1	A DNA (RIGHT-HANDED DNA)	246
24.4.2	B DNA (RIGHT-HANDED DNA)	246
24.4.3	Z DNA (LEFT-HANDED DNA)	246
24.5	FUNCTIONS OF DNA	247
	25. DNA REPLICATION-	249
25.1	BASIC RULE FOR REPLICATION OF ALL NUCLEIC ACIDS	250
25.2	TYPES OF REPLICATION	250

25.3	EVIDENCE FOR THE SEMICONSERVATIVE MODE OF REPLICATION	252
25.4	VARIATIONS FROM THE GENERALIZED SCHEME	255
25.5	PROKARYOTIC DNA REPLICATION	257
25.5.1	INITIATION	258
25.5.2	ELONGATION	261
25.5.3	TERMINATION	261
25.6	EUKARYOTIC DNA REPLICATION	263
25.6.1	MECHANISM (LOCATION IN) OF CELL CYCLE	264
25.6.2	DYNAMICS AT THE REPLICATION FORK	267
25.6.3	TERMINATION OF REPLICATION	268
	26.STRUCTURE AND TYPES OF RNA	270
26.1	STRUCTURE	270
26.2	TYPES OF RNA	271
26.2.1	MESSENGER RNA (MRNA)	272
26.2.2	RIBOSOMAL RNA (RRNA)	273
26.2.3	TRANSFER RNA (TRNA)	274
	27. ROLE OF RNA IN PROTEIN SYNTHESIS	278
27.1	INTRODUCTION	278
27.2	PROTEIN SYNTHESIS	279

27.3	PROKARYOTIC VS. EUKARYOTIC PROTEIN SYNTHESIS	280
27.4	DIFFERENCES BETWEEN PROKARYOTIC AND EUKARYOTIC PROTEIN SYNTHESSES	280
27.5	MRNA, TRNA, AND RRNA	281
27.6	PROTEIN BIOSYNTHESIS	282
27.7	STEPS OF PROTEIN BIOSYNTHESIS:	282
27.8	REGULATION OF PROTEIN SYNTHESIS	285
27.8.1	REGULATION BY MEANS OF OPERONS	285
27.8.2	REGULATION BY INDUCTION	285
27.8.3	REGULATION BY REPRESSION	286
27.8.4	REGULATION BY POSITIVE CONTROL	287
27.8.5	REGULATION BY CATABOLITE REPRESSION	288
27.8.6	REGULATION BY ATTENUATION	288
	More important questions	291

UNIT III

CELL AND MOLECULAR BIOLOGY

1. MICROSCOPE

1.1 INTRODUCTION



- A general definition of microbes includes all those living organisms that can not be viewed (seen) in any detail by the human eye. Alternatively, a microbe is any living creature that must be examined with a magnifying lens in order to see its unique physical characteristics (size, shape, motility, color).
- Microscopes are instruments designed to produce magnified visual images of objects too small to be seen with the naked eye. The microscope must accomplish three tasks: produce a magnified image of the specimen, separate the details in the image, and render the details visible to the human eye.

1.2 TYPE OF MICROSCOPE

A) Light microscope: The magnification of light microscope is obtained by a system of optical lenses using light waves.

B) Electron microscope: A beam of electron is used in place of light waves to produce the image

A. Light microscope

- ❖ There are two basic types of light microscope - simple and compound. The simple microscope has one lens between the object and the eye. The compound microscope has a lens, often made up of several elements, at their object end (objective) and a lens, of several elements, at the eye end (eye piece). Simple microscopes often have lower magnification than compound microscopes.

1.2.1 Simple Microscope:

- ❖ More than five hundred years ago, simple glass magnifiers were developed. The “simple microscope” or magnifying glass reached its highest state of perfection, in the 1600’s, in the work of Anton von
- ❖ Leeuwenhoek who was able to see single-celled animals (which he called “animalcules”) and even some larger bacteria with a simple microscope similar to the one illustrated in following diagram. These were convex lenses (thicker in the center than the periphery). The specimen or object could then be focused by use of the magnifier placed between the object and the eye. These “simple microscopes” could spread the image on the retina by magnification through increasing the visual angle on the retina.

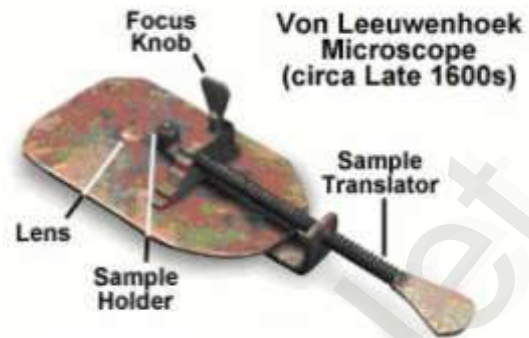

1.2.2 THE COMPOUND LIGHT MICROSCOPE

- ❖ Anton van Leeuwenhoek of Delft, Holland, constructed simple microscopes composed of double convex glass lenses held between two silver plates. His microscopes could magnify around 50 to 300 times. Microbiologists currently use a variety of light microscopes. Modern microscopes are all compound microscopes. The light microscopy refers to the use of any kind of microscope that uses visible light to make the specimens observable. The most commonly used light microscopes are:

- ✓ Bright field microscopes
- ✓ Dark-field microscopes
- ✓ Phase contrast microscopes
- ✓ Fluorescence microscopes

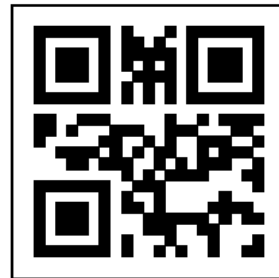

- ❖ Each type of microscope is adapted for certain type of observations. The standard ordinary light microscope is called a bright-field microscope, because it forms a dark image against a brighter background. A compound microscope with a single eye piece (ocular) is called monocular and with two eye pieces is called binocular.

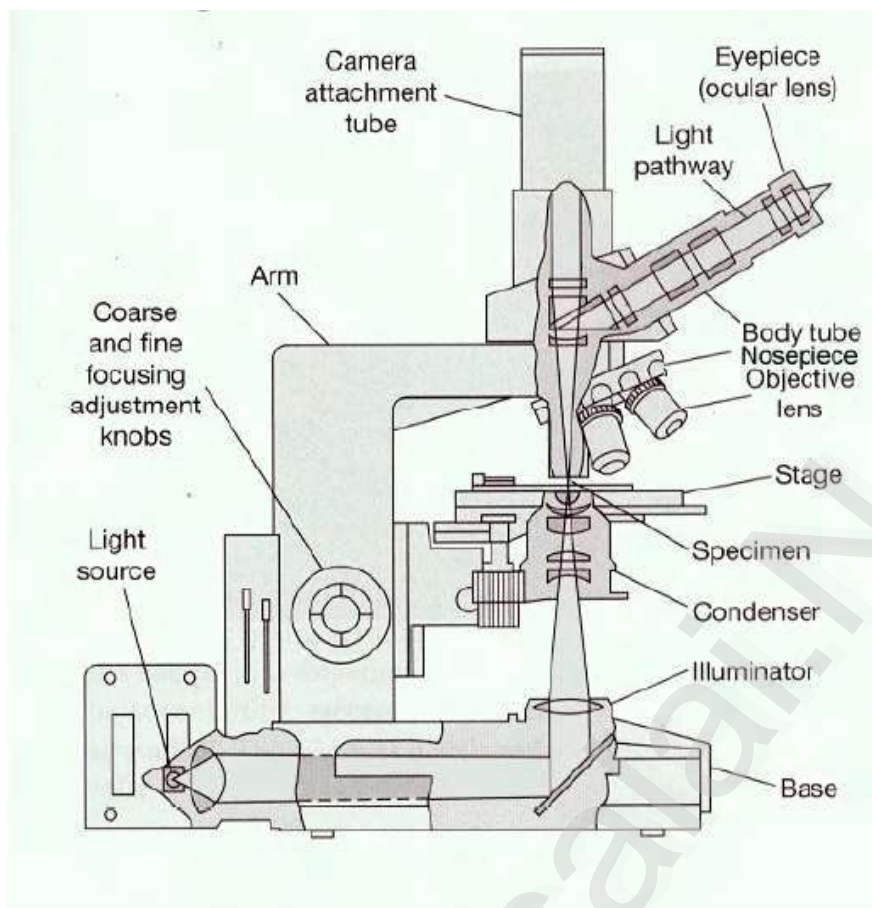

- ❖ A mirror or an electric illuminator is a light source which is located in the base of the microscope.
- ❖ There are two focusing knobs, the fine and the coarse adjustment knobs which are located on the arm. These are used to move either the stage or the nosepiece to focus the image.
- ❖ The mechanical stage is positioned about halfway up the arm, which allows precise contact of moving the slide. The sub stage condenser is mounted within or beneath the stage and focuses a cone of light on the slide. In simpler microscopes, its position is fixed whereas in advanced microscopes it can be adjusted vertically.
- ❖ The upper part of the microscope arm holds the body assembly. The nose piece and one or more eyepieces or oculars are attached to it. The body assembly contains a series of mirrors and prisms so that the barrel holding the eyepiece may be tilted for viewing.
- ❖ Three or five objectives with different magnification power are fixed to the nose piece and can be rotated to the position beneath the body assembly. A microscope should always be par focal, i.e. the image should remain in focus when objectives are changed.

- ❖ Light enters the microscope from the base and passes through a blue filter which filters out the long wavelengths of light, leaving the shorter wavelengths and improving the resolution. The light then goes through the condenser which converges the light beams so that they pass through the specimen. The iris diaphragm controls the amount of light that passes through the specimen and into the objective lens. For higher magnification, greater the amount of light needed to view the specimen clearly.
- ❖ The objective lens magnifies the image before it passes through body tube to the ocular lens in the eyepiece. The ocular of light needed to view the specimen clearly. The objective lens magnifies the image before it passes through body tube to the ocular lens in the eyepiece.
- ❖ The ocular lens further magnifies the image. The total magnification of the light microscope is calculated by multiplying the magnifying power of the objective lens by the magnifying power of the ocular lens.
- ❖ Representative magnification values for a 10 X ocular are:
 - ✓ Scanning (4X) x (10X) = 40X magnification
 - ✓ Low power (10X) x (10x) = 100X magnification
 - ✓ High dry (40X) x (10X) = 400X magnification
 - ✓ Oil Immersion (100X) x (10X) = 1000X magnification

1. Microscope Resolution

- ❖ Objective is the important part in the microscope which is responsible to produce a clear image. The resolution of the objective is most important. Resolution is the capacity of a lens to separate or distinguish between small objects that are close together. The major factor in the resolution is the wave length of light used. The greatest resolution obtained with light of the shortest wavelength, that is the light at the blue end of the visible spectrum in the range of 450 to 500 nm. The highest resolution possible in a compound light microscope is about 0.2 μm .
- ❖ That means, the two objects closer together than 0.2 μm are not resolvable as distinct and separate. The light microscope is equipped with three or four objectives. The working distance of an objective is the distance between the front surface of the lens and the surface of the cover glass or the specimen. Objectives with large numerical apertures and great resolving power have short working distances.

2. Numerical Aperture

- ❖ The resolving power of a light microscope depends on the wavelength of light used and the numerical aperture (NA) of the objective lenses. The numerical aperture of a lens can be increased by
 - increasing the size of the lens opening and/or
 - increasing the refractive index of the material between the lens and the specimen.
- ❖ The larger the numerical aperture the better the resolving power. It is important to illuminate the specimens properly to have higher resolution. The concave mirror in the microscope creates a narrow cone of light and has a small numerical aperture. However, the resolution can be improved with a sub stage condenser. A wide cone of light through the slide and into the objective lens increases the numerical aperture there by improves the resolution of the microscope.

The Properties of Microscope objectives

Property	Objectives		
	Low power	High power	Oil immersion
Magnification	10X	40-45X	90-100X
Numerical aperture	0.25	0.55-0.65	1.25-1.4
Approximate focal length (f)	16mm	4mm	1.8-2.0mm
Working distance	4-8mm	0.5-0.7mm	1.8-2.0mm
Approximate resolving power with light of 450 nm (blue light)	0.9 μ m	0.35 μ m	0.18 μ m

3. Oil immersion

- ❖ Oil immersion lens is designed to be in direct contact with the oil placed on the cover slip. An oil immersion lens has a short focal length and hence there is a short working distance between
- ❖ the objective lens and the specimen. Immersion oil has a refractive index closer to that of glass than the refractive index of air, so the use of oil increases the cone of light that enters the objective lens.

www.tcaexamguide.com (95665 35080; 9786269980; 76399 67359; 93602 68118)

Kindly Send me your Answer Keys to email id - Padasalai.net@gmail.com

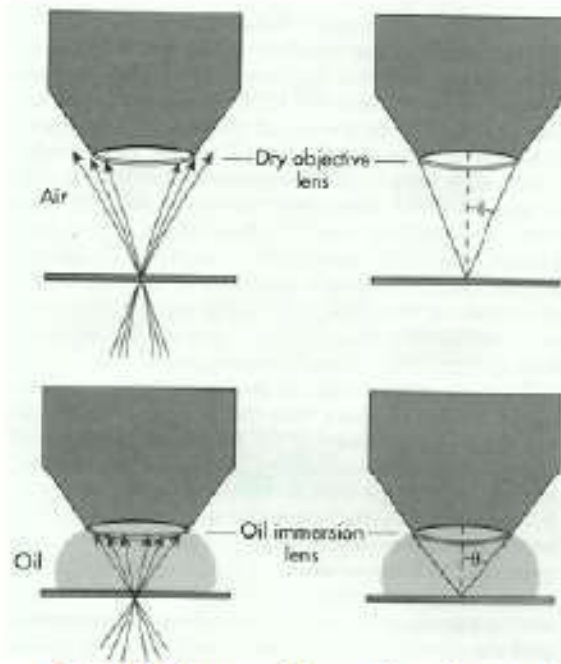

The oil immersion objective and resolution

- ❖ Because of refractive index the light passing from the glass into air makes the light to bend. The light passing from glass through oil does not bend much because the oil has similar refractive index to that of a glass.
- ❖ The immersion oil with a refractive index of about 1.5 increases the numerical aperture and increases the resolving power of the microscope.

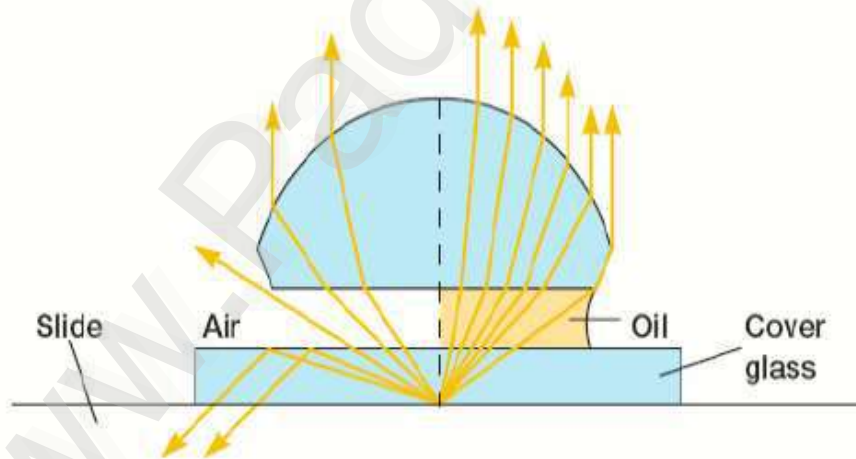

- ❖ The resolution of a microscope depends upon the numerical aperture of its condenser as well as that of the objective. This is evident from the equation describing the resolution of the complete microscope.

$$d_{\text{microscope}} = \frac{\lambda}{(NA_{\text{objective}} + NA_{\text{condenser}})}$$

- ❖ Most microscopes have a condenser with a numerical aperture between 1.2 and 1.4. However, the condenser numerical aperture will not be much above about 0.9 unless the top of the condenser is oiled to the bottom of the slide.

4. Magnification:

- ❖ Normally a microscope is equipped with three or four objectives ranging in magnifying power from 4X to 100X. The **working distance** of an objective is the distance between the front surface of the lens and the surface of the cover glass (if one is used) or the specimen when it is in sharp focus.
- ❖ The largest useful magnification increases the size of the smallest resolvable object enough to be visible. Our eye can just detect a speck 0.2 mm in diameter, and consequently the useful limit of magnification is about 1,000 times the numerical aperture of the objective lens.
- ❖ Most standard microscopes come with 10X eyepieces and have an upper limit of about 1,000X with oil immersion. A 15X eyepiece may be used with good objectives to achieve a useful magnification of 1,500X. Any further magnification increase does not enable a person to see more detail.
- ❖ A light microscope can be built to yield a final magnification of 10,000X, but it would simply be magnifying a blur. Only the electron microscope provides sufficient resolution to make higher magnifications useful.

5. Advantages

- ❖ Simplicity of setup with only basic equipment required.
- ❖ No sample preparation required, allowing viewing of live cells.

6. Limitations

- ❖ Very low contrast of most biological samples.
- ❖ Low apparent optical resolution due the blur of out of focus material.

1.2.3 Dark-Field Microscope

- ❖ Living, unstained cells and organisms can be observed by simply changing the way in which they are illuminated in following figure. A hollow cone of light is focused on the specimen in such a way that unreflected and unrefracted rays do not enter the objective.

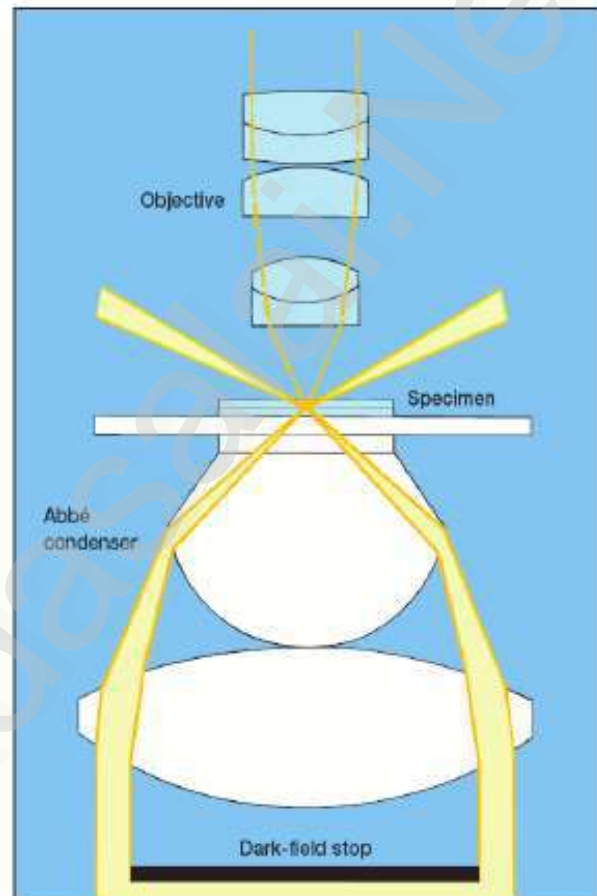
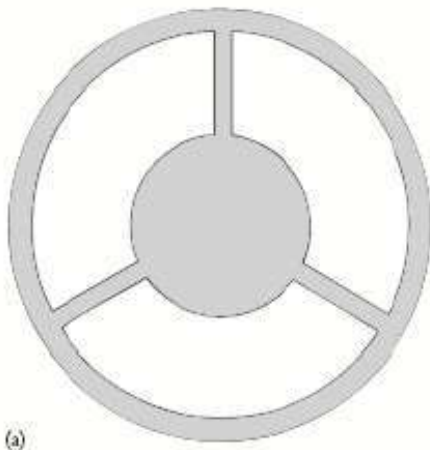

- ❖ **Dark-Field Microscopy:** The simplest way to convert a microscope to dark-field microscopy is to place (a) a dark-field stop underneath (b) the condenser lens system. The condenser then produces a hollow cone of light so that the only light entering the objective comes from the specimen.
- ❖ Only light that has been reflected or refracted by the specimen forms an image. The field surrounding a specimen appears black, while the object itself is brightly illuminated; because the background is dark, this type of microscopy is called dark-field microscopy.

Application:

- ❖ The dark-field microscope is used to identify bacteria like the thin and distinctively shaped *Treponema pallidum* the causative agent of syphilis.
- ❖ Dark field microscopy is a very simple yet effective technique and well suited for uses involving live and unstained biological samples, such as a smear from a tissue culture or individual water-borne single-celled organisms.
- ❖ Considering the simplicity of the setup, the quality of images obtained from this technique is impressive.

Limitation:

- ❖ The main limitation of dark field microscopy is the low light levels seen in the final image. This means the sample must be very strongly illuminated, and can cause damage to the sample.

1.2.4 Phase-Contrast Microscope

- ❖ Unpigmented living cells are not clearly visible in the bright field microscope because there is little difference in contrast between the cells and water. Thus microorganisms often must be fixed and stained before observation to increase contrast and create variations in color between cell structures.
- ❖ **A phase-contrast microscope** converts slight differences in refractive index and cell density into easily detected variations in light intensity and is an excellent way to observe living cells.
- ❖ The condenser of a phase-contrast microscope has an annular stop, an opaque disk with a thin transparent ring, which produces a hollow cone of light in figure. As this cone passes through a cell, some light rays are bent due to variations in density and refractive index within the specimen and are retarded by about $\frac{1}{4}$ wavelength. The deviated light is focused to form an image of the object.
- ❖ Undeviated light rays strike a phase ring in the phase plate, a special optical disk located in the objective, while the deviated rays miss the ring and pass through the rest of the plate.

- ❖ If the phase ring is constructed in such a way that the undeviated light passing through it is advanced by $\frac{1}{4}$ wavelength, the deviated and undeviated waves will be about $\frac{1}{2}$ wavelength out of phase and will cancel each other when they come together to form an image.
- ❖ The background, formed by undeviated light, is bright, while the unstained object appears dark and well-defined. This type of microscopy is called **dark-phase-contrast microscopy** as illustrated in the following diagram. Color filters often are used to improve the image.

Application

- Useful for studying microbial motility
- determining the shape of living cells
- detecting bacterial components such as endospores and inclusion bodies that contain poly--hydroxybutyrate, polymetaphosphate, sulfur, or other substances
- phasecontrast microscopes also are widely used in studying eukaryotic cells.

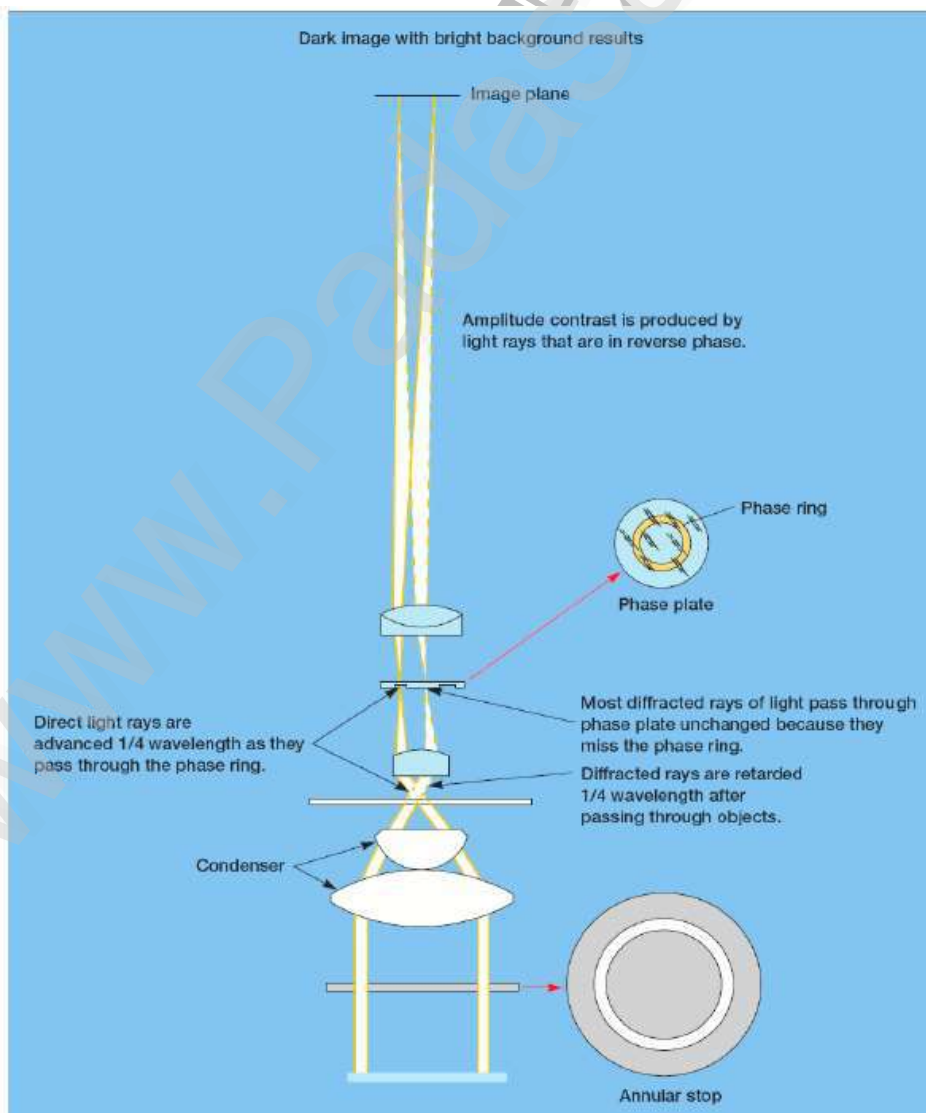

1.2.5 Fluorescence Microscope

- ❖ The fluorescence microscope exposes a specimen to ultraviolet, violet, or blue light and forms an image of the object with the resulting fluorescent light. A mercury vapor arc lamp or other source produces an intense beam, and heat transfer is limited by a special infrared filter as illustrated in the following diagram.

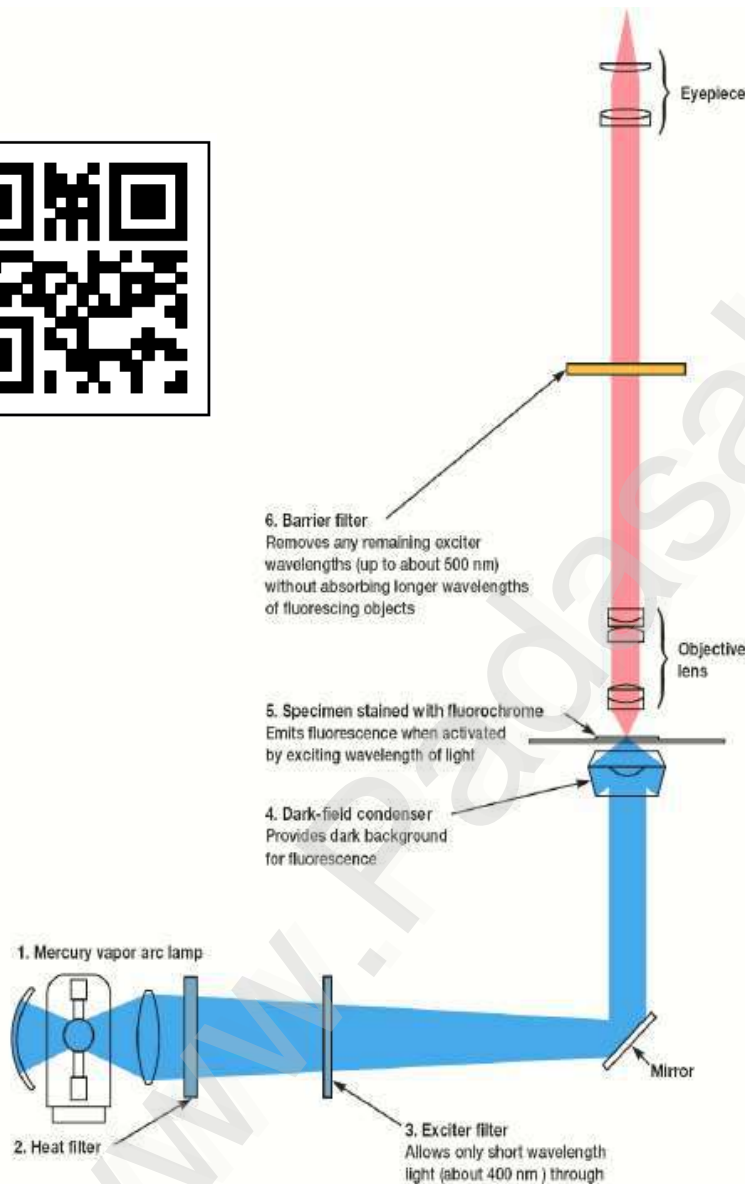

- ❖ The light passes through an exciter filter that transmits only the desired wavelength. A darkfield condenser provides a black background against which the fluorescent objects glow. Usually the specimens have been stained with dye molecules, called fluorochromes that fluoresce brightly upon exposure to light of a specific wavelength but some microorganisms are autofluorescing. The microscope forms an image of the fluorochrome-labeled microorganisms from the light emitted when they fluoresce.

- ❖ A barrier filter positioned after the objective lenses removes any remaining ultraviolet light, which could damage the viewer's eyes, or blue and violet light, which would reduce the image's contrast. The fluorescence microscope has become an essential tool in medical microbiology and microbial ecology.
 - Bacterial pathogens (e.g., *Mycobacterium tuberculosis*, the cause of tuberculosis) can be identified after staining them with fluorochromes or specifically labeling them with fluorescent antibodies using immunofluorescence procedures.
 - In ecological studies the fluorescence microscope is used to observe microorganisms stained with fluorochrome-labeled probes or fluorochromes such as acridine orange and DAPI (diamidino-2-phenylindole, a DNA-specific stain). The stained organisms will fluoresce orange or green and can be detected even in the midst of other particulate material.
 - It is even possible to distinguish live bacteria from dead bacteria by the color they fluoresce after treatment with a special mixture of stains. Thus the microorganisms can be viewed and directly counted in a relatively undisturbed ecological niche.

1.2.6 Electron Microscopy

i) Transmission Electron Microscope

- ❖ The very best light microscope has a resolution limit of about 0.2 μm . Because bacteria usually are around 1 μm in diameter, only their general shape and major morphological features are visible in the light microscope. The electron microscope uses electron beams and magnetic fields to produce the image, whereas the light microscope uses light waves and glass lenses.
- ❖ The transmission electron microscope has a practical resolution roughly 1,000 times better than the light microscope; with many electron microscopes, points closer than 5 \AA or 0.5 nm can be distinguished, and the useful magnification is well over 100,000X.

A. Transmission electron microscope (TEM)

- A beam of electrons generates from a heated tungsten filament in the electron gun generates. It is then focused on the specimen by the condenser. The comparison of Light and Transmission electron microscope is illustrated given below.

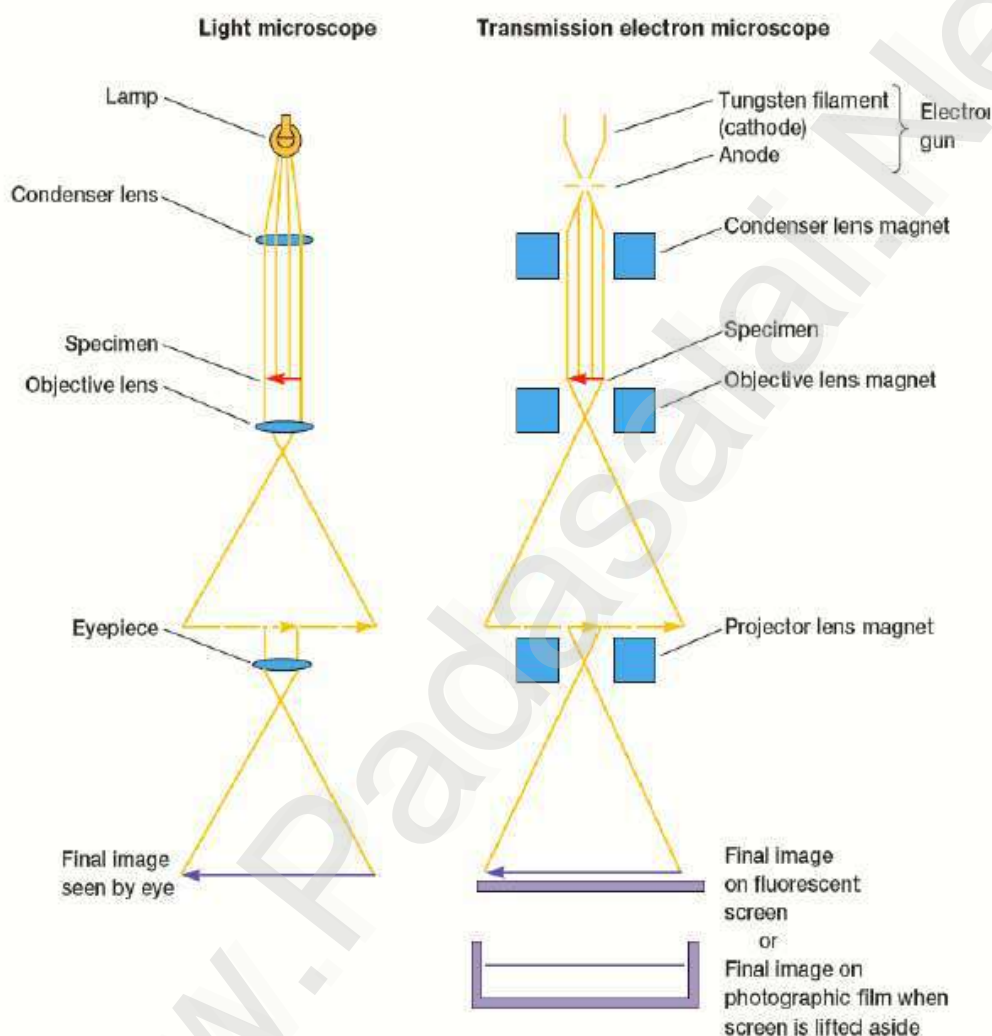

- ❖ **Transmission Electron Microscope Operation.** An overview of TEM operation and a comparison of the operation of light and transmission electron microscopes
- ❖ Since electrons cannot pass through a glass lens, doughnut-shaped electromagnets called magnetic lenses are used to focus the beam. The column containing the lenses and specimen must be under high vacuum to obtain a clear image because electrons are deflected by collisions with air molecules.

More important questions

1. Which of the following cell organelles is absent in animal cells and present in a plant cell?

- (A) Cell wall (B) Cytoplasm
(C) Vacuoles (D) Mitochondria

2. Which of the following cell organelles does not contain DNA?

- (A) Nucleus (B) Lysosomes
(C) Chloroplast (D) Mitochondria

3. Which of the following statements is true about the cell wall?

- (A) The cell wall is mainly composed of lipid
(B) The cell wall is mainly composed of starch
(C) The cell wall is mainly composed of protein
(D) The cell wall is mainly composed of cellulose

4. Which of the following statements is true about cell theory?

- (A) The Cell theory does not apply to fungi
(B) The Cell theory does not apply to virus
(C) The Cell theory does not apply to algae
(D) The Cell theory does not apply to microbes

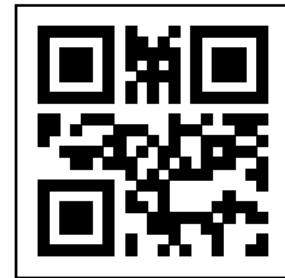

5. _____ is a jellylike substance found floating inside the plasma membrane.

- (A) Cell sap (B) Cytoplasm
(C) Karyoplasm (D) Mitochondria

6. Which of the following cell organelles is called the powerhouse of the cell?

- (A) Nucleus (B) Lysosomes
(C) Chloroplast (D) Mitochondria

7. Which of the following cell organelles regulates the entry and exit of molecules to and from the cell?

- (A) Lysosomes (B) Golgi bodies
(C) Cell membrane (D) Mitochondria

8. _____ is the study of the cell, its types, structure, functions and its organelles.

- (A) Biology (B) Cell Biology
(C) Microbiology (D) Biotechnology

9. Which of the following cell organelles is called a suicidal bag?

- (A) Lysosomes (B) Golgi bodies
(C) Cell membrane (D) Mitochondria

10. Which of the following cell organelles is absent in prokaryotic cells?

- (A) Nucleus (B) Lysosome
(C) Endoplasmic Reticulum (D) All of the above

11. Which of the following cell organelles is involved in the storage of food, and other nutrients, required for a cell to survive?

- (A) Vacuoles (B) Lysosome
(C) Mitochondria (D) Cell membrane

12. Which of the following cell organelles is involved in the breakdown of organic matter?

- (A) Lysosomes (B) Cytoplasm
(C) Golgi bodies (D) Mitochondria

13. _____ is involved in the synthesis of phospholipids.

- (A) Mitochondria (B) Cytoplasm
(C) Endoplasmic Reticulum (D) Smooth Endoplasmic Reticulum

14. Which of the following cell organelles is present in plant cells and absent in animal cells?

- (A) Nucleus (B) Vacuole
(C) Chloroplast (D) Cytoplasm

15. Which of the following statements is true about chromosomes?

- (A) It is present within the nucleus
(B) It carries genes and helps in inheritance
(C) It is composed of DNA in the form of Chromatin and protein
(D) All of the above

16. Which of the following is a single membrane-bound organelle?

- (A) Vacuole (B) Golgi Apparatus
(C) Endoplasmic Reticulum (D) All of the above

17. Which of the following cell organelles is present in animal cells and absent in plant cells?

- (A) Nucleus (B) Centrosome
(C) Golgi bodies (D) All of the above

18. Which of the following is not a double membrane-bound organelle?

- (A) Chloroplast (B) Mitochondria
(C) Endoplasmic Reticulum (D) All of the above

19. Which of the following statements is true about the Golgi bodies?

- (A) It is a sac-like organelle
(B) It is located near the nucleus
(C) It helps in transporting the particles throughout the cell.
(D) All of the above

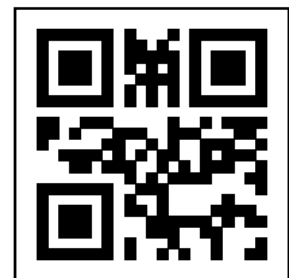



TEACHER'S CARE ACADEMY

38/23, Vaigundaperumal Koil Street, Kanchipuram-1

Mobile : 95665 35080, 97862 69980

Help Line Numbers : 9360268118, 7639967359

UG TRB
Zoology
2022-2023

UNIT - IV
GENETICS

Your Success is Our Goal....

TEACHER'S CARE ACADEMY KANCHIPURAM



ZOOLOGY

UNIT - 4

GENETICS

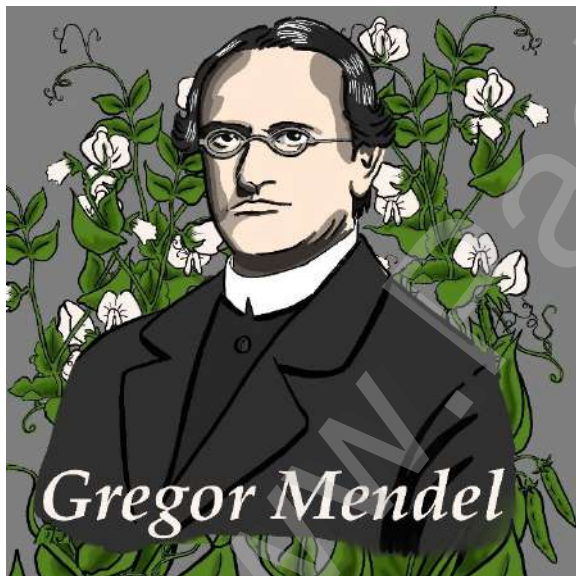

COMPETITIVE EXAM

FOR

UG -TRB-ZOOLOGY 2022 - 23

TEACHER'S CARE ACADEMY, KANCHIPURAM

TNPSC-TRB- COMPUTER SCIENCE -TET COACHING CENTER



**HEAD OFFICE: NO. 38/23, VAIGUNDA PERUMAL KOIL,
SANNATHI STREET, KANCHIPURAM – 1. CELL: 9566535080**

B.Off 2: 65C, Thillai Ngr(West), 4th Cross St, Trichy – 620018

B.Off 3: Vijiyaraghavachariar Memorial Hall(Opp to Sundar Lodge), Salem

Trichy : 76399 67359

Salem : 93602 68118

UG TRB – ZOOLOGY – 2022-23

UNIT – IV

GENETICS

Sl.No	CONTENTS	PAGE
1.	<u>MENDELIAN PRINCIPLE</u>	1
	1.1. MENDALIAN LAWS OF INHERITANCE:	1
	1.2 IMPORTANT TERMS GENE:	2
	1.2.1 ALLELE:	2
	1.2.2 GENOTYPE:	2
	1.3.1. MENDAL'S LAW:	3
	1.3.2 LAW OF DOMINANCE:	3
	1.3.3 LAW OF SEGREGATION:	3
	1.3.4 LAW OF INDEPENDENT ASSORTMENT:	4
	1.3.5 CO-DOMINANCE:	4
	1.3.6 INCOMPLETE DOMINANCE:	4

	1.4. POLYGENIC INHERITANCE:	6
	1.4.1. EXAMPLES OF POLYGENIC INHERITANCE SKIN COLOR:	6
<u>2.</u>	<u>GENE INTERACTIONS</u>	8
	2.1 INTRODUCTION:	8
	2.2 STRUCTURE OF GENE AND FUNCTIONS:	9
	2.3 CLASSIC CONCEPT OF GENE:	9
	2.4 GENE STRUCTURE:	11
	2.5 MOLECULAR STRUCTURE OF GENE:	13
	2.6 DISCONTINUOUS GENES (EXONS AND INTRONS):	15
	2.7 FUNCTIONS OF GENE:	15
<u>3.</u>	<u>MULTIPLE ALLELES</u>	18
	3.1 INTRODUCTION:	18
	3.2 INHERITANCE OF BLOOD GROUP IN MAN: (ABO BLOOD GROUP)	19
	3.3 RH FACTOR:	20
	3.3.1. UNIVERSAL DONOR:	21
	3.3.2 UNIVERSAL RECIPIENT:	22
	3.4 MULTIPLE ALLELES IS COAT COLOR IN RABBITS:	22
<u>4.</u>	<u>MULTIPLE FACTORS</u>	25
	4.1 INTRODUCTION:	25
	4.2 SKIN COLOUR IN MAN:	26
	4.3 INHERITANCE OF FUR COLOUR IN RABBITS:	27

	4.4 SALIENT FEATURES OF QUANTITATIVE/POLYGENIC INHERITANCE:	28
	4.5 DIFFERENCE BETWEEN QUALITATIVE AND QUANTITATIVE CHARACTERS:	29
<u>5.</u>	<u>SEX DETERMINATION:</u>	31
	5.1 SEX CHROMOSOMES:	31
	5.2 CHROMOSOMAL MECHANISMS OF SEX DETERMINATION IN INSECTS:	31
	5.3 SEX DETERMINATION IN DROSOPHILA:	32
	5.4 SEX DETERMINATION IN MAMMALS:	33
	5.5 SEX DETERMINATION IN BIRDS: Z AND W CHROMOSOMES:	34
	5.6 SEX DETERMINATION AND ENVIRONMENT:	36
	5.7 MECHANISMS OF SEX DETERMINATION:	36
	5.7.1. CHROMOSOMAL MECHANISM OF SEX DETERMINATION:	37
	5.7.2 HAPLODIPLOIDY MECHANISM:	37
	5.7.3. GENIC BALANCE SYSTEM:	37
<u>6.</u>	<u>LINKAGE AND CROSSING OVER</u>	38
	6.1 LINKAGE:	38
	6.1.1. ESTIMATION OF LINKAGE, PHASES OF LINKAGE:	38
	6.1.2 PHASES OF LINKAGE:	39
	6.1.3 TYPES OF LINKAGE:	39
	6.1.4 CHARACTERISTIC FEATURES OF LINKAGE:	41

	6.1.5 LINKAGE AND PLEIOTROPY:	41
	6.1.6 LINKAGE GROUPS:	42
	6.1.7 DETECTION OF LINKAGE:	42
	6.1.8 SIGNIFICANCE OF LINKAGE IN PLANT BREEDING:	42
	6.2 CROSSING OVER:	43
	6.2.1 MECHANISM OF CROSSING OVER:	43
	6.2.2 TYPES OF CROSSING OVER:	44
	6.2.3 SIGNIFICANCE OF CROSSING OVER IN PLANT BREEDING:	44
	6.2.4 CYTOLOGICAL PROOF OF CROSSING OVER:	45
	6.2.5 DIFFERENCE BETWEEN CROSSING OVER AND LINKAGE	46
7.	<u>CHROMOSOME ABERRATIONS</u>	48
	7.1 CHROMOSOMAL DISORDERS:	48
	7.2 TYPES OF CHROMOSOME DISORDERS:	49
	7.2.1 NUMERICAL DISORDERS	49
	7.2.1.1 WHAT ARE TRISOMIES?	49
	7.2.1.2 MONOSOMY:	52
	7.2.2 STRUCTURAL CHROMOSOME DISORDERS:	54
	7.2.2.1. FOUR DIFFERENT KINDS OF STRUCTURAL CHANGES OF CHROMOSOME HAVE BEEN DEMONSTRATED:	54
	7.2.2.2 CHROMOSOMAL ABERRATIONS ARE OF 4 MAJOR TYPES:	56

	7.2.3 CHROMOSOME INSTABILITY SYNDROMES:	63
<u>8.</u>	<u>GENE CONTROLLED DISEASE</u>	68
	8.1 AUTOSOMAL DOMINANT INHERITANCE:	69
	8.1.1 AUTOSOMAL DOMINANT INHERITANCE	71
	8.1.1.1 MARFAN SYNDROME:	72
	8.1.1.2 HEREDITARY NONPOLYPOSIS COLORECTAL CANCERORLYNCH SYNDROME:	73
	8.1.1.3 HEREDITARY MULTIPLE EXOSTOSES:	73
	8.1.1.4 TUBEROUS SCLEROSIS:	74
	8.1.2 AUTOSOMAL RECESSIVE INHERITANCE:	74
	8.1.2.1 CYSTIC FIBROSIS:	76
	8.1.2.2 SICKLE CELL ANEMIA:	77
	8.1.2.3 TAY-SACHS DISEASE:	79
	8.1.3 WHAT IS X-LINKED INHERITANCE?	79
	8.1.3.1 .X-LINKED DOMINANT INHERITANCE:	80
	8.1.3.2 X-LINKED RECESSIVE INHERITANCE:	81
<u>9.</u>	<u>EXTRA CHROMOSOMAL DISEASE</u>	83
	9.1 MITOCHONDRIAL GENETIC DISORDERS	83
	9.2 SYMPTOMS:	84
	9.3 CAUSES:	84
	9.4 INHERITANCE:	85
	9.5 DIAGNOSIS:	86

	9.6. EXERCISE TESTING:	86
	9.7 FRAGILE X SYNDROME	87
	9.8 MITOCHONDRIAL DISEASE:	88
	9.8.1 GENOCOPIES OF MITOCHONDRIAL DISEASE:	89
	9.8.2 PHENOCOPIES OF MITOCHONDRIAL DISEASE:	89
10.	<u>MENDELIAN TRAITS</u>	90
	10.1 INTRODUCTION:	90
	10.2 MENDELIAN INHERITANCE IN HUMANS:	90
	10.3 AUTOSOMAL TRAITS:	90
	10.4 SEX-LINKED TRAITS	91
	10.5 PEDIGREE STUDIES:	93
11.	<u>EUGENICS-GENETICS AND SOCIETY</u>	97
	11.1 INTRODUCTION	97
	11.2 THE BETTERMENT OF HUMAN SOCIETY CAN BE ACHIEVED BY FOLLOWING TWO INTER-RELATED METHODS:	97
	11.3 WHEN WE CONSIDER THE FUTURE WELFARE OF THE HUMAN RACE THEN THE FOLLOWING TWO FACTORS ALARM US GREATLY:	99
	11.4 THE EUGENICS CAN BE APPLICABLE BY ADOPTING FOLLOWING TWO METHODS:	99
	11.4.1 POSITIVE EUGENICS:	99
	11.4.2. NEGATIVE EUGENICS:	102

<u>12.</u>	<u>NUCLEIC ACIDS-DNA AND RNA CHEMICAL BASIS OF HEREDITARY</u>	107
	12.1 DNA STRUCTURE AND FUNCTION:	107
	12.1.1 STRUCTURE OF DNA:	107
	12.1.2 CHEMICAL COMPOSITION OF DNA:	109
	12.1.3 WATSON AND CRICK DOUBLE HELIX MODEL OF DNA:	112
	12.1.4 TYPES AND FORMS OF DNA:	113
	12.2 RNA (RIBONUCLEIC ACID):	116
	12.2.1 INTRODUCTION:	116
	12.2.2 PROPERTIES OF RNA:	116
	12.2.3 STRUCTURE OF RNA:	117
	12.2.4 COMPOSITION OF RNA:	117
	12.2.5 TYPES OF RNA	118
	12.2.6 SOME OTHER TYPES OF RNA	119
	12.2.7 FUNCTIONS OF RNA:	120
<u>13.</u>	<u>GENE MUTATION</u>	121
	<u>13.1 MUTATION:</u>	121
	13.2 TYPES OF MUTATION:	123
	13.2.1 LETHAL MUTATION:	123
	13.2.2 BIOCHEMICAL MUTATION:	123
	13.2.3 RESISTANT MUTATION:	123

	13.2.4. MUTATION IN NON-CODING SEQUENCE:	123
	13.3 CATEGORIES OF MUTATIONS:	123
	13.3.1 SOMATIC MUTATIONS:	124
	13.3.2 GERM-LINE MUTATION:	124
	13.3.3 SPONTANEOUS AND INDUCED MUTATIONS:	124
	13.4 SPONTANEOUS MUTATIONS:	124
	13.5 INDUCED MUTATIONS:	129
<u>14.</u>	<u>GENETICS OF BACTERIA</u>	135
	14.1. CONJUGATION:	136
	14.1.1 DEFINITION:	136
	14.1.2 TYPES:	138
	14.2 TRANSDUCTION	142
	14.2.1 GENERALIZED TRANSDUCTION:	142
	14.2.2 SPECIALIZED TRANSDUCTION:	143
	14.3 TRANSFORMATION:	145
	14.3.1 DEFINITION:	145
	14.3.2 MECHANISM:	145
	14.3.3 COMPETENCE:	146
	14.3.4 LIFE CYCLE OF PHAGES	146
<u>15.</u>	<u>THE GENETIC CODE</u>	149
	15.1 ELUCIDATING THE GENETIC CODE:	149

	15.2 GENERAL NATURE OF THE GENETIC CODE:	149
	15.3 THE NATURE OF THE GENETIC CODE:	150
	15.4 WOBBLE HYPOTHESIS:	151
	15.5 SALIENT FEATURES:	151
<u>16.</u>	<u>GENE ACTION</u>	154
	16.1 TYPES OF GENE ACTION:	155
	16.1.1 DIHYBRID RATIO (9:3:3:1):	156
	16.1.2 DUPLICATE RECESSIVE EPISTASIS (COMPLIMENTARY GENE ACTION) 9:7	156
	16.1.3 DUPLICATE GENE ACTION (15:1) (DUPLICATE DOMINANT EPISTASIS)	156
	16.1.4 INHIBITORY GENE ACTION (13:3)	157
	16.1.5 SUPPLEMENTARY GENE ACTION. (RECESSIVE EPISTASIS) 9:3:4	157
	16.1.6 ADDITIVE FACTORS (9:6:1) (POLYMERIC GENE ACTION)	157
	16.1.7 DOMINANT EPISTASIS (12:3:1)	157
	16.1.8 MODIFYING GENES	158
	16.2 MAJOR AND MINOR GENES	158
	16.3 INHERITANCE OF QUANTITATIVE CHARACTERS	158
	16.3.1 CONCEPT OF POLYGENES	158
	16.3.2 MULTIPLE FACTOR HYPOTHESIS (NILSSON - EHLE 1908)	159
	16.3.3 TRANSGRESSIVE SEGREGATION	159
	16.3.4 EXPRESSIVITY	160

	16.3.5 PENETRANCE	160
	16.3.6 POLYDACTYLY	160
17.	<u>REGULATION OF GENE EXPRESSION</u>	161
	<u>17.1.1 LAC OPERON:</u>	162
	<u>17.1.2 TRP OPERON</u>	164
18.	<u>TRANSPOSABLE ELEMENTS</u>	167
	18.1 CHARACTERISTICS OF TRANSPOSABLE ELEMENTS:	167
	18.2 MECHANISM OF TRANSPOSITION:	168
	18.2.1. REPLICATIVE TRANSPOSITION OR COPY PASTE TRANSPOSITION:	168
	18.2.2. CONSERVATIVE OR NON-REPLICATIVE: CUT AND PASTE TRANSPOSITION:	170
	18.2.3 . RETRO-TRANSPOSONS:	170
19.	<u>GENETIC CLONING</u>	171
	19.1 CLONING:	171
	19.2 DNA CLONING STEPS:	173
	19.3 CUTTING AND PASTING DNA:	173
	19.4 BACTERIAL TRANSFORMATION AND SELECTION:	173
	19.5 PROTEIN PRODUCTION:	173
	19.6 IMPORTANCE OF DNA CLONING:	174
	<u>Multiple Choice Questions - Important (113)</u>	175

TEACHER'S CARE ACADEMY, KANCHIPURAM

TNPSC-TRB- COMPUTER SCIENCE -TET COACHING CENTER



**HEAD OFFICE: NO. 38/23, VAIGUNDA PERUMAL KOIL,
SANNATHI STREET, KANCHIPURAM – 1. CELL: 9566535080**

B.Off 2: 65C, Thillai Ngr(West), 4th Cross St, Trichy – 620018

B.Off 3: Vijayaraghavachariar Memorial Hall(Opp to Sundar Lodge), Salem

Trichy : 76399 67359

Salem : 93602 68118

UG TRB – ZOOLOGY – 2022-23

UNIT – IV

GENETICS

1. MENDELIAN PRINCIPLE

1.1. MENDELIAN LAWS OF INHERITANCE:

- ❖ Gregor Johann Mendal was an Austrian monk born in 1882 in the family of poor farmer.
- ❖ *Mendal is considered as the father of genetics.* He performed series of experiments with pea plants in the garden.

Why Mendal Chose Peas?

- ❖ Peas have very short life cycle – takes only 3 months to grow to full height. Easy to grow. Pea plants have a lot of considerable contrasting characters for experiments. Characters had only 2 contrasting traits.
 - 7 characters of pea plant
 - Seed shape – round, wrinkled
 - Seed color – yellow, green
 - Flower color – purple, white
 - Pod shape – inflated, constricted
 - Pod color – yellow, green
 - Flower position – axial, terminal
 - Stem height – tall, dwarf



- Pea is a diploid plant – it contains only two set of chromosome. Because, if polyploidy plants were chosen it will have more set of chromosomes and they will not give simple results.
- Pea plant has perfect flower. It contain both male and female parts in the same flower. Self-fertilized – cross pollination is rare without human intervention. (Experimentally introduced)

1.2 IMPORTANT TERMS GENE:

- Gene is the shortest segment of DNA responsible for the expression of its specific character.
- It is the basic unit of heredity.
- *It is situated on the chromosomes.*
- It determines the biological character of an organism.
- Genome is the total genetic composition of an organism.

1.2.1 ALLELE:

- *Allele is an alternative form of same gene.* For example, in case of plant height, tallness and dwarfness are the two alleles of a gene.
- Allele is of two types namely Dominant and Recessive.
- Out of two alleles, the one that is capable of expressing itself by hiding or suppressing its contrasting allele is known as dominant allele.
- Out of two alleles the one that is being surpassed by its alternative allele is called recessive allele.
- Recessive is an allele that does not express itself when present with dominant allele (heterozygous form).
- A diploid individual carrying two identical allele is known as homozygous.
- It is pure for a trait or character.
- A diploid individual carrying two different alleles is known as heterozygous or hybrid. It is impure for a trait (Tt).

1.2.2 GENOTYPE:

- A genotype is a genetic expression of an organism.
- For a plant height, TT, Tt, tt are the different genotype.

- *Phenotype is the physical or the observable expression of an organism.*
- It is the observable characteristic of an individual.

1.3.1. MENDEL'S LAW:

- ❖ Based on Mendel's experimental results, certain principles are formed. These principles are called Mendel's law. They were:
 - Law of dominance
 - Law of segregation
 - Law of independent assortment

1.3.2 LAW OF DOMINANCE:

- ❖ Mendel's law of dominance states that —when parents with pure, contrasting traits are crossed together, only one form of trait appears in the next generation. The hybrid offspring will exhibit only the dominant traits in the phenotype.
 - Law of dominance is known as first law of inheritance.
 - In this law, each character is controlled by distinct unit called factors, which occurs in pairs.
 - If the pairs are heterozygous, one will always dominate the other.
- ❖ *In simple words, the law of dominance states that recessive traits are always dominated or masked by the dominant traits.*
- ❖ *This law is formulated based on the monohybrid experiment.*
- ❖ The one which is expressed in the F₁ generation is called dominant trait and the one which is suppressed is called recessive traits.

1.3.3 LAW OF SEGREGATION:

- A normal somatic cell has two variants for a Mendelian character, whereas a gamete (pollen, ovule, sperm, egg) contains one allele randomly chosen from the two somatic alleles. □
- Eg: if you have one allele for brown eye (B). one for blue eye (b), somatic cells have Bb and each gamete will carry one of B or b chosen randomly.
- When two different alleles for a trait are brought together in an individual, they stay together but at the time of gamete formation, the two alleles get separated or segregated from one another. So, each gamete has one allele not both.

- *Simply, the law of segregation states that —the paired genes (allelic pairs) separate from one another and are distributed to different sex cells (gamete).*
- Law of segregation is also known as law of purity of gametes.

1.3.4 LAW OF INDEPENDENT ASSORTMENT:

- *Mendel's law of independent assortment states that the alleles of two (or more) different genes get assorted into gametes independently of each other.*
- In other words the allele a gamete receives for one does not influence for another gene
- i.e., according to this law segregation of R and r is independent of the segregation of Y and y. this results in four types of gametes RY, Ry, rY and ry. These combinations of alleles are different from their parental combinations (RR, YY, rr, yy).

1.3.5 CO-DOMINANCE:

- Co-dominance is believed to be a violation of the Law of Dominance.
- When the alleles for a particular trait are co-dominant, they are both expressed equally rather than a dominant allele taking complete control over a recessive allele.
- This means that *when an organism has two different alleles (i.e., is a heterozygote), it will express both at the same time.*

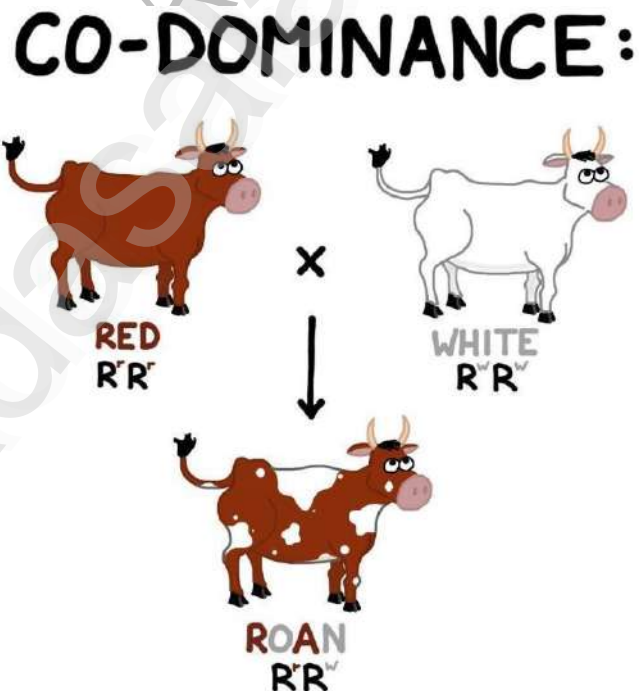

1.3.6 INCOMPLETE DOMINANCE:

- Sometimes in a heterozygote dominant allele does not completely mask the phenotypic expression of the recessive allele and there occurs an intermediate phenotype in the heterozygote. This is called incomplete dominance.
- With co-dominant alleles, both traits are expressed at the same time. With incomplete dominance, the same thing occurs but the traits are blended together rather than occurring in discrete patches.

- It thus refers to the condition in heterozygotes where the phenotype is intermediate between the two homozygotes.

Example.

- In some plants the cross of red and white produces pink-flowered progeny (Four-o'clock plants (*Mirabilis jalapa*) or snapdragons (*Antirrhinum majus*)).

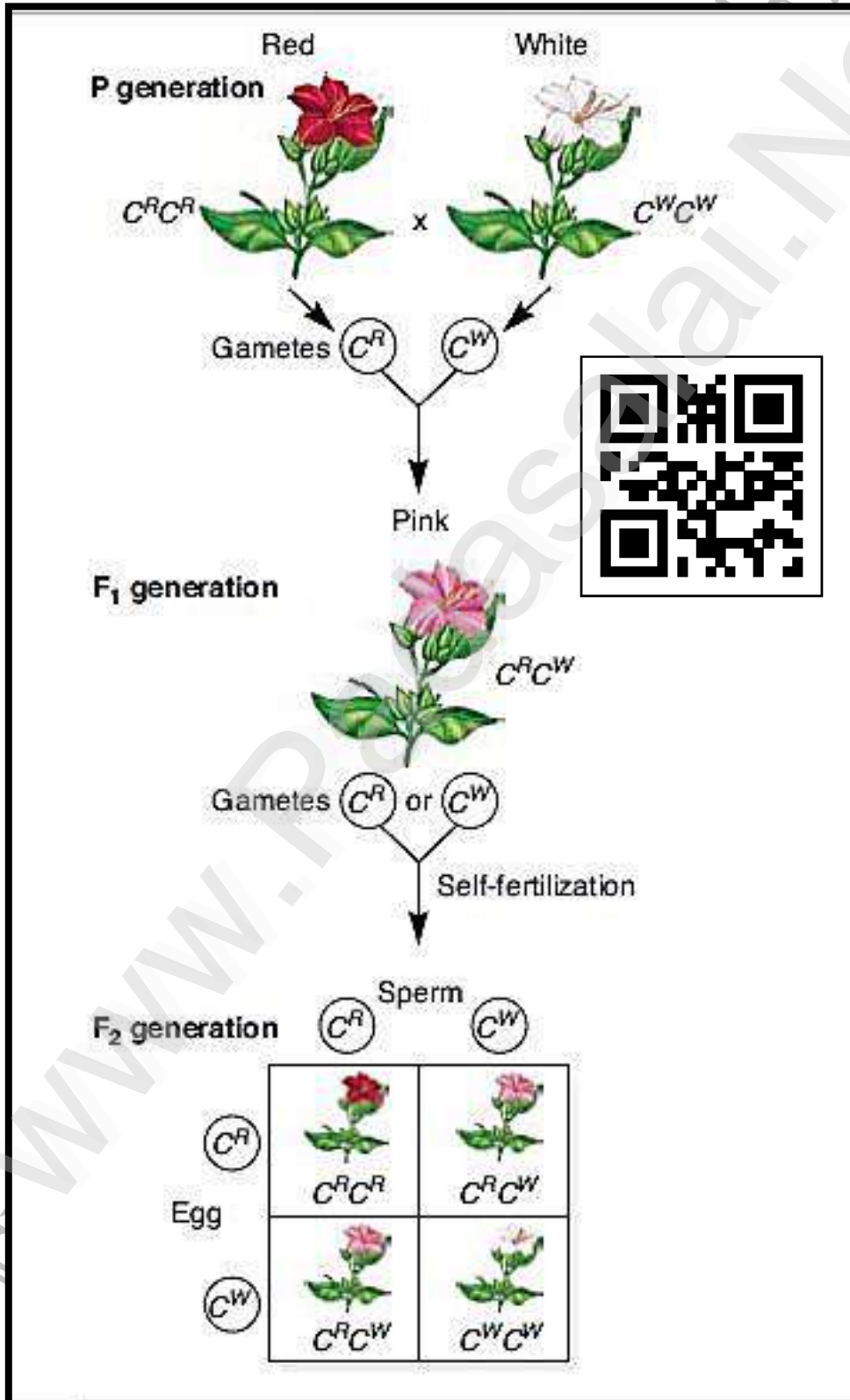

INCOMPLETE DOMINANCE	CODOMINANCE
1. When none of the two alleles is dominant, but these alleles mix up to form a new trait, then it is termed as incomplete dominance.	1. When both the alleles are dominant in nature, and the traits for both the alleles are expressed equally, then its is terms as codominance.
2. Although both the alleles mix up, but only one allele's effect is seen.	2. In codominance, both the alleles mix up equally and their effects are also seen equally.
3. Incomplete dominance always lead to the formation of new phenotype.	3. In codominance, no new phenotype is formed.
4. Example are snapdragon and mirabilis Jalapa.	4. Examples are Roan character is cattle, and blood groups in human.

1.4. POLYGENIC INHERITANCE:

- The traits that are determined by polygenic inheritance are not simply an effect of dominance and recessivity, and do not exhibit *complete dominance* as in Mendelian Genetics, where one allele dominates or masks another. Instead, *polygenic traits exhibit incomplete dominance* so the phenotype displayed in offspring is a mixture of the phenotypes displayed in the parents. Each of the genes that contributes to a polygenic trait, has an equal influence and each of the alleles has an *additive effect* on the phenotype outcome.

1.4.1. EXAMPLES OF POLYGENIC INHERITANCE SKIN COLOR:

- The pigment melanin is responsible for dark coloration in the skin and there are at least three genes, which control for human skin color. Using a hypothetical example where the production of melanin is controlled by *dominant alleles* (denoted here as A, B and C), resulting in dark skin color, and therefore light skin color is produced by *recessive alleles* (denoted here as a, b and c), it is possible to see how the spectrum of different skin colors can result in the offspring.

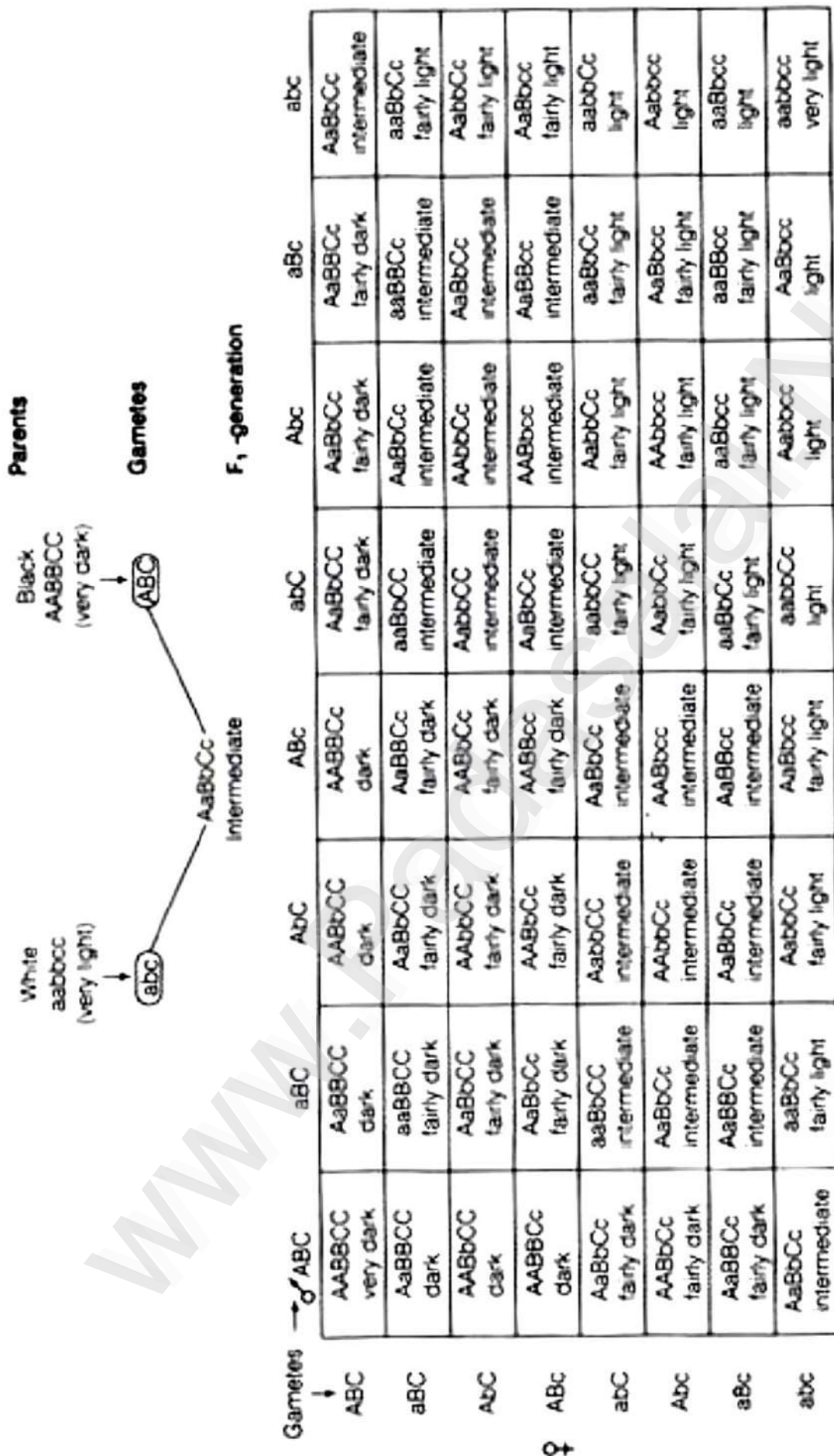

Phenotypes: Very Dark (Black) - 1, Dark-6, Fairly Dark-15, Intermediate-20, Fairly Light-15, Light-6, Very Light (White) - 1.

Fig. 5.6 Quantitative inheritance of skin colour in human beings

1. What branch of biology focusses on the study of patterns of inheritance?
A) Genetics B) Immunology C) Evolution D) Ecology
2. The process of transfer of characters from parents to offspring is referred to as _____.
A) Inheritance B) Heritage C) Genetics D) Variation
3. What determines the differences between the progeny and parents?
A) Inheritance B) Heritage C) Genetics D) Variation
4. Who proposed the laws of inheritance in living organisms?
A) Gregor Mendel B) James Watson C) Francis Crick D) Erwin Chargaff
5. What technique in plant biology was used by Gregor Mendel to derive the patterns of inheritance?
A) Hybridization B) Mutagenesis C) Exportation D) Importation

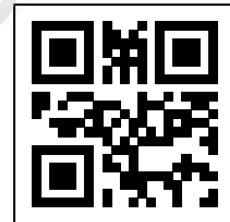

2. GENE INTERACTIONS

- ❖ Genetic interaction is **the set of functional association between genes**. One such relationship is epistasis, which is the interaction of non-allelic genes where the effect of one gene is masked by another gene to result either in the suppression of the effect or they both combine to produce a new trait.
- ❖ Genes are the hereditary units responsible for the transfer of genetic characters from the one generation to the next, located in the chromosomes in a linear fashion. The gene is to genetics what the atom is to chemistry.
- ❖ It is also said that genes are like catalysts which bring about reactions without being changed or consumed. One chromosome carries a number of genes. In the last chapter, you had read about the chromosomes and chromosomal mutations. In this chapter, you will read about the genes, roles or functions of genes, the structure of genes and modern gene concept.

2.1 INTRODUCTION:

- Mendel assumed in his experiments the presence of "unit determiners" responsible for hereditary characters. These unit determiners are now referred to as "genes". The term gene was introduced by Wilhelm Johannsen in 1909. The gene is that specific area of the chromosome which determines a particular character.

- After the rediscovery of Mendel's laws in 1900, Walter S. Sutton (1902) pronounced chromosome theory of heredity, according to which the chromosomes are the carriers of hereditary particles or determiners (genes). During the second decade of this century, many concepts of genes were established by Thomas Hunt Morgan, A. H. Sturtevant, C. B. Bridges, and H. G. Muller on *Drosophila*.
- Their results were in accord with the chromosome theory put forward by Sutton. So it was finally established that the genes, controlling hereditary characters are carried on the chromosomes, act as vehicles to carry these genes from one generation to next.

2.2 STRUCTURE OF GENE AND FUNCTIONS:

- ❖ Based on classic concept following definitions of genes were suggested by various scientists:

A. Gene, the Unit of Function:

- According to this definition gene is the smallest unit of a chromosome and as well as of physiological activity.

B. Gene, The Unit of Mutation:

- According to it the gene is the smallest unit, capable of undergoing mutation.
- Morgan (1925) defined the gene "as a particle in the chromosome which is distinguishable from other **particles either by crossing over or mutation.**

C. Gene, The Unit of Transmission:

- According to Castle, the gene is the smallest particle of chromatin capable of self-duplication and is the ultimate unit of heredity.
- Based upon its subdivisions the gene or cistron may be defined "as the functional unit segment of DNA consisting of several subunits (or nucleotide pairs) called mutons or recons

- ❖ " Thus, the gene is the smallest segment of the chromosome whose activity can produce a definite effect. So, the phenotype is the physiological effect of the gene. But it is not always correct because sometimes functional effectiveness of a gene depends upon other neighboring genes and there might be overlapping regions of gene function.

2.3 CLASSIC CONCEPT OF GENE:

- ❖ The gene concept was introduced by Sutton. The theory of gene, formulated by T. H. Morgan, is a summary of the *information about characters genes, chromosomes, linkage and crossing over.

A lot about the nature of a gene is now established which leads to the classic concept of the gene. The essential features of the modern concept of genes are as following:

- 1) Inheritance of biparental i.e. both male and female parents contribute equally in the inheritance of characters to the next generation
- 2) Genes determine the physical as well as physiological characteristics. These are transmitted from parents to the offspring's generation after generation.
- 3) Characters of an individual are determined by paired genes situated in a definite number of chromosome pairs or linkage groups.
- 4) Genes are situated in the chromosome in a linear fashion like the arrangement of beads on a string.
- 5) Several genes are present in each chromosome; all such genes of the same chromosomes are called as linked genes.
- 6) In man about 40,000 genes are known to be located on 23 pairs of chromosomes (46 chromosomes).
- 7) Each gene occupies a specific position on a specific chromosome. This position is known as a locus (pl. loci).
- 8) At mutation, the members of each pair of genes separate so that either of the gametes possesses only one gene of that kind.
- 9) Pairs of genes held in different chromosomes or linkage groups are assorted independently.
- 10) A single gene may occur in several forms or in several functional states. The forms other than normal are known as alleles.
- 11) Many genes have only two alleles; one of them is normal and another one is its mutant.
- 12) Only those genes are known which have their alternative alleles.
- 13) The alleles may be related as dominant or recessive but not always.
- 14) Genes lie in a linear order in their chromosomes and other remains constant until and unless crossing over or mutation takes place.
- 15) Gene in one chromosome may be shifted to another of the same homologous pair. It may be either due to crossing over or due to translocation.

- 16) Some genes mutate more than once and have more than two alleles. These are known as multiple alleles.
- 17) The genes may undergo a sudden change in expression due to change in its composition. The changed gene is known as mutant gene and the phenomenon of change is known as mutation.
- 18) Rarely genes from one chromosome may be exchanged or transferred to another chromosome which may be its homologous counterpart (crossing over) or non-homologous (translocation).
- 19) Genes duplicate themselves very accurately. The phenomenon is known as replication. Self-duplication of genes leads to chromosomal duplication.
- 20) Two or more pair of genes may interact to produce a trait (interaction of genes).
- 21) Inbreeding leads to homozygosity and out breeding to heterozygosity and hybrid vigor.
- 22) Genes express themselves by producing enzymes which are proteins. It means each gene synthesizes a particular protein which acts as an enzyme and brings about an appropriate change.

2.4 GENE STRUCTURE:

❖ The structure of a gene may be studied in the following headings:

- A. LOCATION OF GENE:** According to Demerec (1939) genes are located on the chromosome along its entire length in a linear fashion. The chromosomal threads are alike both chemically and physically, side branches at right angles which are given out from the chromosome and these bear genes. The genes on the one branch may be alike or unlike, both physiologically and chemically.
- B. GENES AND GENOME:** Organisms possess a definite number of the chromosome, and no doubt, the number varies from species to species. The number becomes half during gametogenesis. The total number of chromosomes found in gametes constitutes one genome. Thus, the genome can be expressed as the total sum of genes present on the haploid set of chromosomes. Diploid organisms never contain more than two genomes while haploid organisms are never more than one genome.
- C. GENE SIZE:** The genes are very fine structure and these are too difficult to be measured directly. The size consideration of gene implies that it has certain definite limits. Furthermore, when the gene is said to be functional and behavioral in structure, it is difficult to measure its size directly.

Multiple Choice Questions - Important

- 1) When a heterozygous dominant and homozygous recessive are crossed with each other, then the ratio in the next filial generation will be:
- A) 1:2 B) 2:1 C) 3:1 D) 1:1
- 2) Probability of occurrence of four sons in a couple is
- A) $\frac{1}{4}$ B) $\frac{1}{8}$ C) $\frac{1}{16}$ D) $\frac{1}{32}$
- 3) A gamete generally contains
- A) two alleles of a gene B) one allele of a gene
C) many alleles of a gene D) all alleles of a gene
- 4) An individual having two identical members of a pair of genetic factors is called
- A) heteromorphic B) heterozygote C) homomorphic D) homozygote
- 5) A plant is heterozygous and is designated as Bb. If it produces two kinds of the gametes B and b. The probability of b gamete fertilizing B or b will be
- A) $\frac{1}{2}$ B) $\frac{1}{1}$ C) $\frac{0}{1}$ D) $\frac{1}{4}$
- 6) The plants are considered to be true breeding when
- A) all the plants of the parental generation resemble each other
B) the progeny occupies less space
C) the progeny may show genetic variability which may finally be utilised for evolving a better type
D) the progeny is free of disease
- 7) Using two pairs-tall and dwarf and smooth and wrinkled seeds the principle of independent assortment of characters is proved by the
- A) observation that F1 progeny is tall
B) appearance of tall and dwarf in 3:1 ratio and also the appearance of smooth and wrinkled seeded plants in 3:1 ratio in F2 population
C) appearance of tall and dwarf plants in F2 population
D) appearance of smooth and wrinkled seeded plants, F2 population
- 8) The percentage of ab gametes produced by AaBb parent will be
- A) 12.5 B) 25 C) 50 D) 75

- 9) Dominant gene for tallness is T and for yellow colour is Y. If a plant heterozygous for both the traits is selfed, then the ratio of pure homozygous dwarf and green offsprings would be
- A) $\frac{1}{4}$ B) $\frac{4}{16}$ C) $\frac{3}{16}$ D) $\frac{1}{16}$
- 10) How many pairs of contrasting characters in pea pod were considered by Mendel in this cross?
- A) 2 B) 3 C) 4 D) 7
- 11) A cross between an F1 hybrid and a recessive parent gives the ratio of
- A) 3:1 B) 1:1 C) 2:1 D) 4:1
- 12) If a homozygous tall male plant (dominant) is crossed with a homozygous dwarf male plant (recessive), the genotype of endosperm would be
- A) tt B) ttT C) TTt D) TTT
- 13) How many types of genetically different gametes would be produced by a heterozygous plant having the genotype AABbCc
- A) 2 B) 4 C) 6 D) 9
14. The genes controlling 7 traits in pea studied by Mendel were later found to be located on how many chromosomes?
- A) 7 B) 4 C) 5 D) 6
15. In a monohybrid cross red colour of flower (RR) is dominant over white colour of flower (rr). What will be the phenotypic ratio of the offspring from a cross between Rr x rr parents?
- A) 50% red and 50% white B) 75% red and 25% white
C) 100% red D) 100% white
- 16) If a dwarf plant was treated with gibberellic acid, it grew as tall as the pure tall plant. If this treated plant is crossed with pure tall plant, then the phenotypic ratio of F1 generation is likely to be
- A) 50% dwarf and 50% tall B) 75% tall and dwarf 25%
C) all dwarf D) all tall
- 17) The universally applicable law of Mendel is
- A) law of dominance B) law of unit characters
C) law of segregation D) law of independent assortment
- 18) Genotypic and phenotypic ratios are same in
- A) a cross involving sex linked traits
B) a test cross
C) monohybrid cross in which homozygous dominant alleles become lethal
D) none of these

- 19) In a dihybrid cross what percentage of F1 progeny are obtained for both the traits?
A) 8% B) 12.5% C) 25% D) 50%
- 20) In codominance F1 hybrids show
A) both dominant and recessive characters
B) only dominant character
C) only recessive character
D) the intermediate character between dominant and recessive
- 21) In case of incomplete dominance in F2 generation
A) genotypic ratio 3:1
B) phenotypic ratio is 3:1
C) genotype ratio is equal to phenotypic ratio
D) nothing can be concluded
- 22) Which of the following statements about crossing-over is most correct?
A) There are as many crossings over possibilities as there are genes on the chromosome.
B) The farther apart are the two genes on the chromosome, greater are the chances of their crossing over.
C) Genes placed linearly adjacent on a chromosome have the greatest chances of crossing over
D) crossing over does not occur at a distance of more than 5 map units
- 23) Linkage was discovered by
A) Blakeslee B) Sutton C) Muller D) Bateson
- 24) Often two genes do not assort independently as predicted by Mendel's principle of independent assortment. However, even in such linked genes, linked it is never complete because of
A) crossing over
B) the phenomenon of dominance
C) inversions
D) certain enzymes which cleave DNA between two genes
- 25) Repulsion and coupling are two faces of
A) mutation B) chiasmata C) linkage D) crossing over





TEACHER'S CARE ACADEMY

38/23, Vaigundaperumal Koil Street, Kanchipuram-1

Mobile : 95665 35080, 97862 69980

Help Line Numbers : 9360268118, 7639967359

UG TRB
Zoology
2022-2023



UNIT - V
ANIMAL PHYSIOLOGY

Your Success is Our Goal....

TEACHER'S CARE ACADEMY KANCHIPURAM



ZOOLOGY

UNIT - 5

ANIMAL PHYSIOLOGY

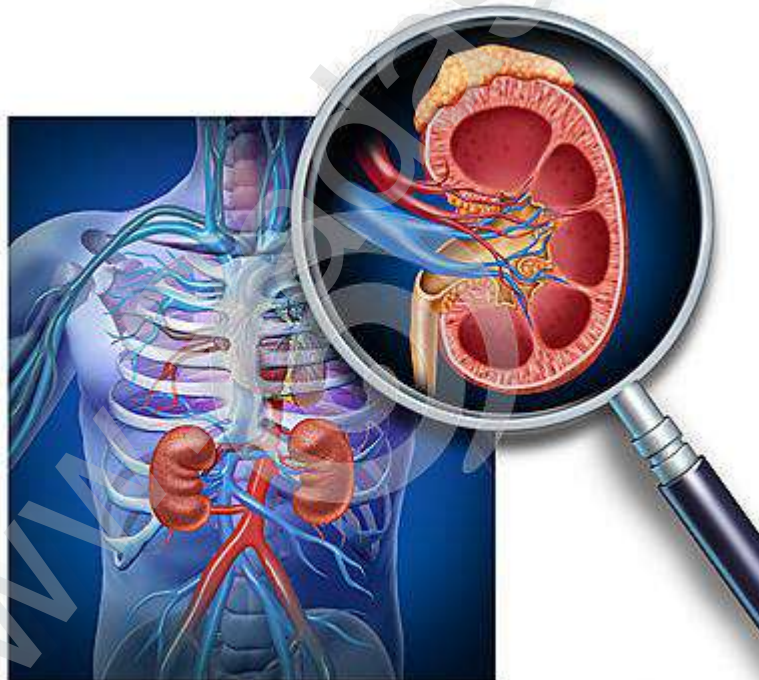

COMPETITIVE EXAM

FOR

UG -TRB-ZOOLOGY 2022 - 23

TEACHER'S CARE ACADEMY, KANCHIPURAM

TNPSC-TRB- COMPUTER SCIENCE -TET COACHING CENTER



**HEAD OFFICE: NO. 38/23, VAIGUNDA PERUMAL KOIL,
SANNATHI STREET, KANCHIPURAM – 1. CELL: 9566535080**

B.Off 2: 65C, Thillai Ngr(West), 4th Cross St, Trichy – 620018

B.Off 3: Vijiyaraghavachariar Memorial Hall(Opp to Sundar Lodge), Salem

Trichy : 76399 67359

Salem : 93602 68118

UG TRB - 2022 - 2023

ZOOLOGY

UNIT V - ANIMAL PHYSIOLOGY

INDEX

S.No	CONTENTS		PAGE
1.	Nutrition		1
1.1	Types of Nutrition		1
	1.1.1	On the Basis of Sources of Food	1
	1.1.2	On the Basis of Nature of Food it is Following types	1
	1.1.3	Steps in Nutrition	2
1.2	Food and Nutrition		2
	1.2.1	Properties of water	3
	1.2.2	Food constituents – protein	3
	1.2.3	Classification of proteins	4
	1.2.4	Chemical composition of proteins	7
	1.2.5	Structure of protein	8
	1.2.6	Functions of protein	9

1.3	Carbohydrates		10
	1.3.1	Sugars	10
	1.3.2	Non-sugars	10
	1.3.3	Functions of carbohydrates	12
1.4	Lipids		13
	1.4.1	Structure of lipids	13
	1.4.2	Classification of lipids	14
	1.4.3	Properties of lipids	16
	1.4.4	Biological importance of lipids	17
1.5	Vitamins		17
	1.5.1	Classification of vitamins	18
1.6	Feeding mechanisms in animals		28
2	Digestive enzymes and their role in digestion		31
2.1	Introduction		31
2.2	Digestion in mouth		31
	2.2.1	Chewing	31
2.3	Digestion in stomach		32
	2.3.1	Gastric Secretion	33
	2.3.2	Gastric Juice	34
	2.3.3	Activities of Gastric Secretion	34
2.4	Digestion in Small Intestine		36
	2.4.1	Nature and actions of Pancreatic Enzymes	36
	2.4.2	Intestinal Juice	39

2.5	Absorption	41
	2.5.1 Mechanism of Absorption	41
	2.5.2 Carbohydrate Absorption	42
	2.5.3 Protein Absorption	43
	2.5.4 Absorption of Fats	45
	2.5.5 Absorption of Nucleic Acids	46
	2.5.6 Absorption of Water	46
	2.5.7 Faeces	47
	2.5.8 Defecation	48
3.	Respiration	49
3.1	Respiratory Organs Structure and Function	50
	3.1.1 Respiratory system parts	50
	3.1.2 Respiratory system functions	52
3.2	Mechanism of Respiration in Human	53
3.3	Respiratory Pigments	57
	3.3.1 Functions of Respiratory Pigments	60
	3.3.2 Role of respiratory pigments in the transport of o ₂ and co ₂ in man	61
3.4	Transport of Respiratory Gases	62
	3.4.1 Transport of oxygen	62
	3.4.2 Oxygen dissociation curve	65
	3.4.3 Transport of carbondioxide	67
3.5	Chloride shift (hamburger effect)	69

	3.5.1	Mechanism of the Chloride Shift	69
	3.5.2	Magnitude of the Chloride Shift	72
	3.5.3	Significance of the Chloride Shift	72
3.6	Haldanes and Bohr Effect		73
4	Circulatory System		79
4.1	Structure of the Human Heart		79
	4.1.1	External Structure of Heart	80
	4.1.2	Internal Structure of Heart	81
4.2	Cardiac Cycle		83
4.3	Origin of Heart Beat		92
4.4	Pace Maker		93
	4.4.1	Risks / Benefits	95
4.5	Electrocardiogram (ecg)		97
4.6	Blood Pressure		98
	4.6.1	Resistance of Blood Flow	99
	4.6.2	Effect to Pressure on Vascular Resistance – Critical Closing Pressure	100
	4.6.3	Compliance or Capacitance	100
	4.6.4	Cardiac Output	101
	4.6.5	Types of Blood Pressure	101
	4.6.6	Blood Pressure vs. Heart Rate	102
4.7	Blood		105
	4.7.1	What is blood?	105
	4.7.2	Types of Blood Cells	106

	4.7.3	Blood Vessels	110
5	Human Excretory System		113
5.1	Excretory System Organs		113
	5.1.1	Kidneys	114
5.2	Excretion in Humans		115
	5.2.1	Mechanism of Excretion in Humans	116
	5.2.2	Dialysis	117
5.3	Nephron		118
	5.3.1	Structure of Nephron	118
	5.3.2	Types of Nephron	120
	5.3.3	Functions of Nephron	121
	5.3.4	Urine Formation	121
	5.3.5	Mechanism of Urine Formation	122
5.4	Hormonal Regulation of the Excretory System		123
	5.4.1	Antidiuretic Hormone (adh)	123
	5.4.2	Epinephrine and Norepinephrine	126
	5.4.3	Renin-angiotensin-aldosterone	126
	5.4.5	Mineralocorticoids	126
	5.4.6	Antidiurectic hormone	127
	5.4.7	Atrial Natriuretic Peptide Hormone	127
6	Osmoregulation		129
	6.1	Types of Osmoregulation	129
	6.2	Osmoregulation in Different Organisms	129

7	Thermoregulation	132
7.1	How does Thermoregulation work?	134
7.2	Mechanism of Thermoregulation	134
7.3	Importance of Thermoregulation	135
8	Muscular System	137
8.1	What are Muscles?	137
8.2	Properties of Muscular Tissue	137
8.3	Structure of Muscular Tissue	138
8.4	Types of Muscles	138
8.5	Skeletal Muscles Structure and Chemical Composition	139
8.6	Mechanism of Muscle Contraction	142
9	Nervous system	147
9.1	Structure of Neuron	148
9.2	Parts of a Neuron	149
	9.2.1 Dendrites	150
	9.2.2 Soma (cell body)	150
	9.2.3 Axon	151
	9.2.4 Myelin Sheath	151
	9.2.5 Axon Terminals	151
9.3	Types of Neurons	152
	9.3.1 Sensory neurons	153
	9.3.2 Motor Neurons	153
	9.3.3 Relay Neurons	154

9.4	Nerve Impulse in Myelinated and Non Myelinated Neuron		154
	9.4.1	Conduction of Nerve Impulse	155
9.5	Action Potential		158
9.6	Spinal Nerves		160
9.7	Synapses		160
9.8	The Neuromuscular Junction: Structure and Function		162
	9.8.1	Components	162
9.9	Reflex Action		164
	9.9.1	Action of Neuron	165
	9.9.2	Types of Reflex Action	166
	9.9.3	Significance of Reflex Action	167
9.10	Spinal Cord Reflexes		168
9.11	Reflex Arc		168
10	Photoreceptors		172
10.1	Photopigments		176
11	Phonoreceptor and Physiology		176
11.1	Mechanism of Hearing		176
11.2	Ear Diseases		176
11.3	Maintenance of Equilibrium		176
11.4	Middle Ear		177
11.5	Internal Ear		177
11.6	External Ear		177
11.7	Endocrine Glands and Hormones		178

12	Chemoreception	180
13	Human endocrine system- endocrine glands	183
13.1	Hypothalamus	183
13.2	Hormones of Pituitary Gland or Hypophysis	184
	13.2.1 Hormones of Adenohypophysis	185
	13.2.2 Hormones of Neurohypophysis	186
13.3	Thyroid Gland	186
	13.3.1 Parathyroid Gland	188
	13.3.2 Parathyroid hormone or Parathormone (PTH)	188
13.4	Pineal Gland	189
	13.4.1 Anatomy of the Pineal Gland	189
	13.4.2 Pineal Hormones	189
13.5	Thymus Gland	190
13.6	Adrenal Gland	191
13.7	Pancreas	191
14	Defects of Hormones	197
15	Hormones involved in Reproduction	201
16	Menstrual Cycle	206
16.1	Phases	206
	16.1.1 Menstrual Phase	207
	16.1.2 Follicular or Proliferative Phase	207
	16.1.3 Ovulatory phase	207
	16.1.4 Luteal or secretory phase	207

TEACHER'S CARE ACADEMY, KANCHIPURAM

TNPSC-TRB- COMPUTER SCIENCE -TET COACHING CENTER



**HEAD OFFICE: NO. 38/23, VAIGUNDA PERUMAL KOIL,
SANNATHI STREET, KANCHIPURAM – 1. CELL: 9566535080**

B.Off 2: 65C, Thillai Ngr(West), 4th Cross St, Trichy – 620018

B.Off 3: 266-C - Advaita Ashram Road, Opp to New Bus Stand, Salem – 4

Trichy: 76399 67359

Salem: 93602 68118

UG TRB 2022 - 23

zoology

1. NUTRITION

- ❖ An important necessity of all living organisms is to obtain energy and matter. Energy is essential to drive the metabolic activities.
 - The materials required for the growth and metabolism are known as nutrients.
 - The process by which the animal obtains these nutrients is known as nutrition.
 - Most of the animals are heterotrophs. (hetero= different, trophic nutrition)
 - It means that animals depend on others for their food.

1.1. TYPES OF NUTRITION:

1.1.1. On The Basis Of Sources Of Food

1. Autotrophic nutrition:

- In this method, the organism can obtain the food from sun light. Eg. Euglena (photo synthesis) or from chemicals (chemosynthesis) Eg. Bacteria.

2. Heterotrophic nutrition:

- In this method, animals depend on other organisms for its food. It is the characteristic feature of animals.

1.1.2 On the basis of nature of food it is of following types.

- 1) **Herbivores** (Herb=plant, vore= to eat). Their food mainly consists of plant material.
Ex. Cow
- 2) **Carnivores** (Cornis= flesh). Their food mainly consists of flesh. Ex. Tiger.
- 3) **Omnivores** (Omni= all). Their food consists of both plant and animal materials. Ex.
Man, Cockroach.

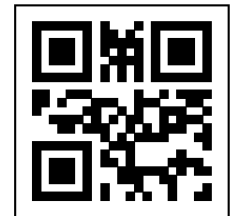

- 4) **Detrivores.** They mainly feed upon dead organic matter.Ex. Eartworm
- 5) **Predators.** They obtain the food by hunting and killing the animal. Ex.Tiger, Eagle.
- 6) **Scavengers.** They mainly feed upon other dead animals.
- 7) **Insectivores.** They feed on insects. Ex. Manis (ant eater).
- 8) **Osmotrophic.** They feed on pre digested food by diffusion. Ex.Taenia solium.
- 9) **Parasitic.** They depend for the food on their host. Ex. Ascaris.
- 10) **Larvivorous.** They feed upon larvas.Fishes.
- 11) **Sanguivorous.** They feed upon blood. Ex.Leech,Mosquito
- 12) **Coprophagous.** Their food consists of faecal matter. Ex.rabbit,Pig

1.1.3 Steps in Nutrition

- 1) **Ingestion:** Intaking of food
- 2) **Digestion:** Breaking of complex and large molecules into simple soluble components.
- 3) **Absorption:** Entry of the digested food from the intestine into blood.
- 4) **Assimilation:** Reuse of simple components into complex components in the cell. This process occurs according to the necessity of the cell.
- 5) **Egestion:** This is the final step. The elimination of undigested food as faeces is known as egestion.

1.2. FOOD AND NUTRITION

- ❖ Foods are the substances which are essential for growth and development of an organism.
- ❖ All living organism need food, some of organisms such as plant make their own food by process of photosynthesis while animals obtain their food from plants and other animal.
- ❖ Two hydrogen atoms and one oxygen atom form a water molecule.
- ❖ These atoms are linked together by covalent bonds.
- ❖ The three molecules in a water molecule are not arranged in a linear pattern.
- ❖ Instead, they are in the form of the letter 'V'.
- ❖ The oxygen atom lies at the tip of 'V' and the hydrogen atoms occupy the ends of the two limbs.

- ❖ The oxygen atom is negatively charged and the hydrogen atoms are positively charged. Thus, the water molecule is a dipole or polar compound.
- ❖ Generally polar compounds tend to attach each other.
- ❖ Thus, the water molecules are held together by this force. A water molecule can link with 4 adjacent water molecules.
- ❖ This linking is done by hydrogen bond. Hydrogen bonds are weak in nature. So, they break and reform continuously. When temperature is raised, the bonds are increasingly broken.

1.2.1 PROPERTIES OF WATER:

- ❖ Water has highest boiling point.
- ❖ It has highest melting temperature.
- ❖ It has highest specific gravity.
- ❖ High heat of vaporization.
- ❖ High latent heat.
- ❖ Has maximum density at 4o C.
- ❖ It has very high surface tension.
- ❖ It has high viscosity.
- ❖ It transmits light effectively.
- ❖ It is a very good solvent.

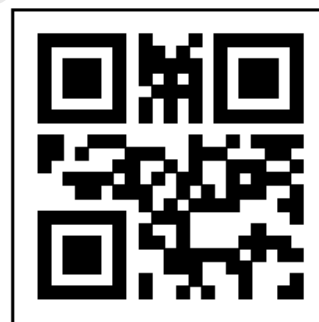

1.2.2 FOOD CONSTITUENTS – PROTEIN

- ❖ Proteins are called body builders.
- ❖ They are formed of carbon, nitrogen, hydrogen, oxygen and at times sulphur.
- ❖ The amino acids are the basic units of proteins.
- ❖ Proteins are macromolecules composed of one or more polypeptide chains.

1. Amino acids:

- ❖ Amino acids are the basic units of monomers or building blocks of proteins.
- ❖ An amino acid consists of;
 - ❖ An amino group (NH₂),
 - ❖ A carboxyl group (COOH),

- ❖ A hydrogen atom,
- ❖ A R group or a side chain or alkali And A carbon atom.

NH₂

H C COOH

R

- ❖ Even though more than 100 amino acids are there, the human as well as other living organisms including bacteria contain only 20 amino acids in their biological system. Each amino acid is linked with the other by means of peptide bond (amide bond)
- ❖ The peptide bond lies between the α - carboxyl groups of adjacent amino acids.
- ❖ The two amino acids linked by a peptide bond forms a dipeptide by losing one water molecule. When more than 10 amino acids are linked together, they form a polypeptide chain. These polypeptides form protein.

1.2.3 CLASSIFICATION OF PROTEINS:

- ❖ The proteins are classified into two main groups,
 - 1) On the basis of their solubility or shape
 - 2) On the basis of increasing complexity of structure

1. Protein classification on the basis of their solubility or shape:

- ❖ Globular proteins and fibrous proteins come under this category.
- ❖ The globular proteins are spherical shaped
- ❖ The enzymes, hormones, antibodies, hemoglobin and myoglobin are globular proteins. These are branched proteins.
- ❖ They are soluble in water.
- ❖ Polypeptide chains of globular proteins are linked by peptide bonds tightly.
- ❖ The tight folding leads to the globular structure.
- ❖ The fibrous proteins are insoluble in water
- ❖ These are unbranched, because of their linear arrangement.
- ❖ Fibrous proteins are the structural proteins.
- ❖ They include collagen of tendons, elastin, fibroin, of silk, keratin of hair, Actin and muscle fibres.

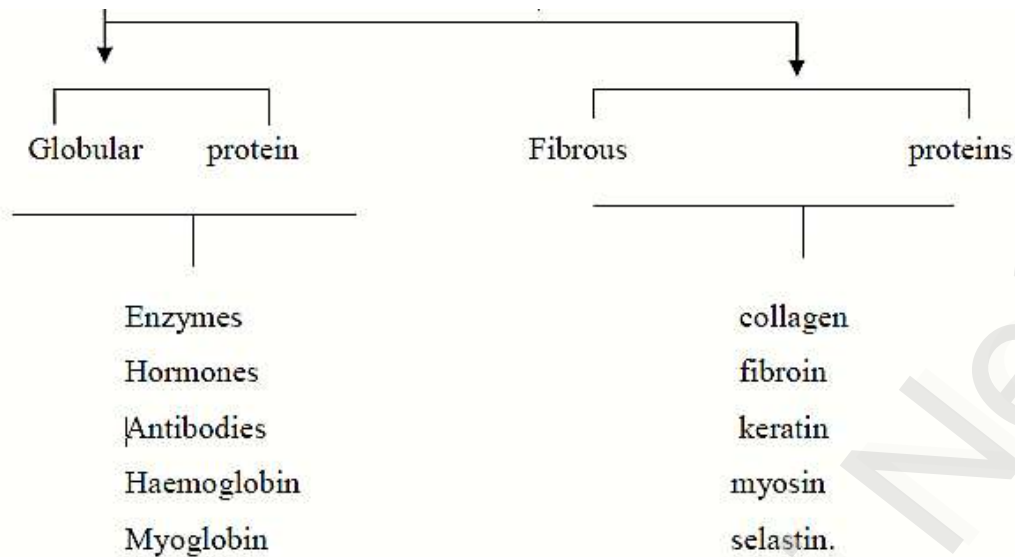

Globular protein Fibrous proteins

- ❖ Enzymes collagen
- ❖ Hormones fibroin
- ❖ Antibodies keratin
- ❖ Haemoglobin myosin
- ❖ Myoglobin selastin.

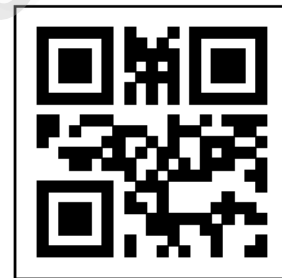

2. Classification of protein on the basis of complexity of structure.

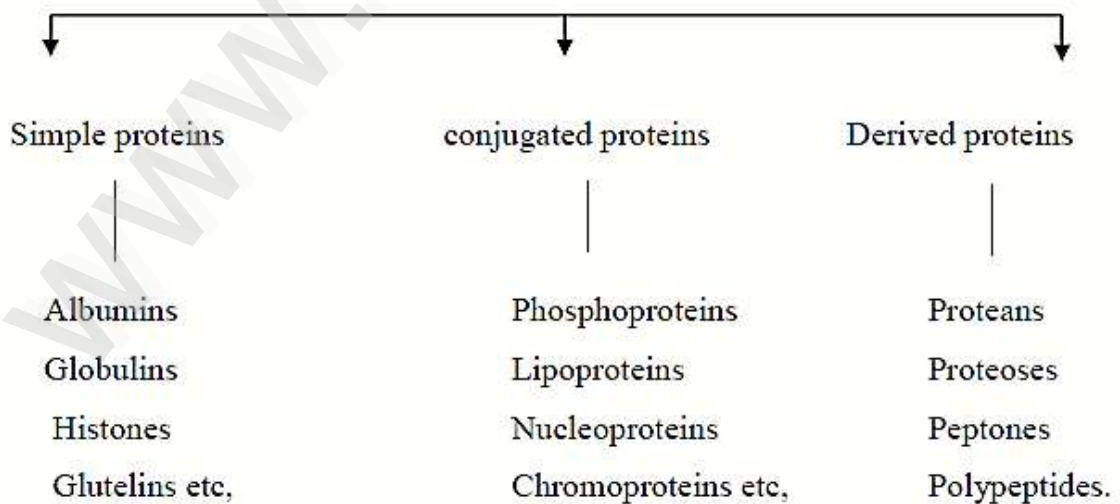

Simple proteins conjugated proteins Derived proteins

- ❖ Albumins Phosphoproteins Proteans
- ❖ Globulins Lipoproteins Proteoses
- ❖ Histones Nucleoproteins Peptones
- ❖ Glutelins etc, Chromoproteins etc, Polypeptides.

1. Simple proteins:

- ❖ When a protein yield amino acid or its derivative on hydrolysis it is called simple protein. They are albuminoids, histones, glutelins, proamines, protamines.
- ❖ Albumins are soluble in water.
- ❖ They get coagulated on heating.
- ❖ (Eg) serum albumin of egg, plasma albumin etc.
- ❖ Prolamins are soluble in 70-80% ethyl alcohol. They are insoluble in water.
- ❖ (Eg) gliadin, zein etc.,.
- ❖ Histones are soluble in water and dilute acids. They are not coagulated by heat. They are combined with haemoglobin and nucleic acids.
- ❖ Glutalines are insoluble in water. They become coagulated on heat.
- ❖ Globulins are proteins insoluble in water.
- ❖ (Eg) serum globulin, plasma globulin etc.,.
- ❖ Protamines are simple proteins, soluble in water (eg) salmine, clupeine etc,

2. Conjugated proteins:

- ❖ When protein combine with a non protein substance, it is called conjugated protein. So, on hydrolysis the conjugated proteins yield non- proteins along with amino acids. The conjugated proteins are classified as follows.
- ❖ Glycoproteins – protein + carbohydrate – egg albumin serum Albemarle.
- ❖ phosphoproteins – protein +phosphoric acid – Casein, vitelline.
- ❖ Lipoproteins – protein + lipid – lipo proteins of blood serum.
- ❖ Nucleoproteins – protein + nucleic acid – nuclein.
- ❖ Chromoproteins – protein + metallicgroup – hemoglobin, haemocyanin etc.,.

3. Derived proteins:

- ❖ When natural proteins are hydrolyzed by heat, acids, alkalies or enzymes, they produce intermediate products. They are called derived proteins.
- ❖ These are further classified into,
- ❖ Primary derived proteins and
- ❖ Secondary derived proteins.
- ❖ Primary derived proteins are derived from proteins in which the side of the molecule is not materially altered. It is of these types namely, proteins, meta proteins and coagulated proteins.

a. Secondary derived proteins:

- ❖ These are the products of proteins in which definite hydrolysis takes place. They are of three types namely proteases, peptones and poly peptides.

1.2.4 Chemical composition of proteins:

- ❖ Amino acids are the basic units of proteins molecule. Two amino acids are linked together by peptide bonds. Thus they constitute a dipeptide.
- ❖ When peptide is formed of less than 10 amino acids, they are called oligopeptides. It is formed of more than 10 amino acids it is called a polypeptide.

1. N and C terminals of amino acid:

- ❖ The amino acids have two ends. One end is called amino group end and the other end is called carboxyl group end. The amino group end is called N- terminal or amino terminal and the other end is called carboxyl terminal or C-terminal
- ❖ Thus the polypeptide chain or protein has a direction.
- ❖ The N-terminal of an amino acid is considered to be the beginning
- ❖ In a polypeptide chain two parts are there. They are the main chain and side chain regions. The main chain has regularly repeating units. The side chain has variable part.
- ❖ In some proteins side chains are cross-linked by disulphide bonds (s-s). The polypeptides form a protein. They may be of same type or different type.

2. Properties of protein:

- ❖ Mostly proteins are colloidal in nature. Very few are crystalline in nature (Eg) insulin
- ❖ Except chromo proteins, other proteins are colourless.

- ❖ Proteins have no taste.
- ❖ They are odourless.
- ❖ Highly viscous in nature
- ❖ The molecular weight of proteins may vary from 30,000 to a few million.
- ❖ Proteins are levorotatory in nature
- ❖ Proteins undergo hydrolysis.
- ❖ When proteins undergo hydration they get precipitated.
- ❖ Proteins can coagulate with alkaline solutions.
- ❖ Proteins are soluble in small concentrations of various mutual salts.
- ❖ Proteins can be oxidized by putrefaction process.
- ❖ Proteins can combine with both acids and bases. So, they exhibit amphoteric nature.
- ❖ The $-NH_2$ groups and $-COOH$ groups of protein can ionize in solution by producing anions and cations. Thus they exist as zwitter ion in solution.
- ❖ Proteins have ionisable $-NH_2$ and $COOH$ group.
- ❖ Proteins become denatured when they are heated, X – rays or treated with UV rays, light, alcohol, acetone etc.,
- ❖ The peptide bond is formed between the carboxyl group (C-terminal) of one amino acid and the amino group (N – terminal) of the adjacent amino acid.
- ❖ Rarely disulphide bond linkage is seen between two adjacent poly peptide chains.

1.2.5 Structure of protein

1. Primary protein

- ❖ Primary structure of proteins are unfolded.
- ❖ Repeated peptide bonds are seen between amino acids.
- ❖ (Eg) Most of the structural proteins are like fibroin of silk.

2. Secondary structure:

- ❖ The helical proteins show secondary structure. When hydrogen bond is formed between amino acid residues, folding of poly peptide chain occurs. So, it forms the helix.

❖ The secondary structure show two types of configurations namely,

✚ **Helical structure And**

✚ **Pleated structure.**

❖ In helical structure the polypeptide chain is coiled like a rope. Here the hydrogen bond is formed between peptide groups within the same polypeptide chain.

❖ Mostly the coiling is right handed - helix. It has screw type symmetry.

❖ Hydrogen bonds occur between every first and fourth peptide group.

❖ It helps to maintain the coiling nature.

❖ The hydrogen bond is formed between two peptide chains.

❖ It leads to the formation of pleatus.

❖ It may be parallel or ant parallel.

3. Tertiary structure:

❖ It is a complex structure.

❖ It occurs in only one poly peptide chain.

❖ It is attained by globular proteins.

❖ Here the secondary structures become folded further.

❖ (eg) Cytochrom C, myoglobin etc,

❖ It shows hydrogen bonds, disulphide bonds and ionic bonds and hydrophobic acids.

4. Quaternary structure: The quaternary structure is formed by the association of two or more polypeptide chains.

❖ It is formed by the union of primary secondary and tertiary structure.

❖ (Eg) Insulin, Haemoglobin.

❖ Homogenous or Heterogenous.

5. Zwitter ions:

❖ Amino acids behave as zwitter ion contains both positive and negative charges. It contains dipolar ions.

1.2.6 Functions of protein:

❖ Most of the enzymes are proteins in nature.

- ❖ The hormones are also proteins.
- ❖ Haemoglobin contains protein which helps in the transport of O₂.
- ❖ These are the body builders.
- ❖ They produce energy and heat.
- ❖ They help for growth, repair of tissues etc.,
- ❖ Proteins of nucleic acids are of genetical importance.
- ❖ Myosin, keratin etc, are proteins which act as structural proteins.
- ❖ Proteins of immunoglobulin act as antibodies.

1.3 CARBOHYDRATES

- ❖ Carbohydrates are the energy sources of the living system.
- ❖ They are hydrates of carbon.
- ❖ Carbohydrates are optically active polyhydroxy aldehydes or ketenes.
- ❖ They are classified into two groups namely, sugars and Nonsugars.

1.3.1. SUGARS:

- ❖ These are carbohydrates with sweet taste.
- ❖ These are readily soluble in water.
- ❖ These are further classified into monosaccharide and oligosaccharides.
- ❖ Monosaccharide are simple sugars. They cannot be further hydrolyzed into simple forms. They are sweet in nature. (Eg) glucose, fructose etc.,
- ❖ Oligosaccharides can give rise to monosaccharides when they are hydrolyzed. (Eg) Lactose, maltose etc.,
- ❖ Based on the number of sugars, the oligosaccharides are classified as, Disaccharides, Trisaccharides etc.,

1.3.2 NON-SUGARS:

- ❖ These carbohydrates are not sweet in taste.
- ❖ They are insoluble in water. (Eg) starch, cellulose, chitin etc.,
- ❖ They are called polysaccharides.

- ❖ They are classified as homopolysaccharides and heteropolysaccharides.
- ❖ If the same type of monosaccharide are linked together to form a polysaccharide, it is called homopolysaccharide.
- ❖ If different type of monosaccharide are linked together, it is called heteropolysaccharide is further divided into natural sugars and mucopolysaccharides.

1. Monosaccharides

- ❖ Monosaccharides are sugars.
- ❖ They cannot be further simplified on hydrolysis.
- ❖ They are crystalline in nature.
- ❖ They are readily soluble in water.
- ❖ The general formula is $(CH_2O)_n$. Mostly they are reducing agents.
- ❖ Some important monosaccharide are glycerose, ribose, mannose, fructose, glucose etc.
- ❖ Monosaccharide contain one or more asymmetric carbon atoms. Based on the number of carbon atoms, they are classified as Trioses, tetroses, pentoses etc.,
- ❖ The classification of monosaccharide is based on the presence of carbonyl group in them. So, they are of aldoses and ketoses.
- ❖ Aldolases have aldehyde group. (CHO)
- ❖ Ketoses have ketone group. (C=O)
- ❖ Monosaccharide may show a straight chain structure or cyclic structure.
- ❖ Straight chain structure-(eg) glucose.
- ❖ Cyclic chain structure-(eg) hexose's.
- ❖ Monosaccharides are colorless sugars.
- ❖ They are crystalline in nature.
- ❖ They are readily soluble in water.
- ❖ They are sweet in nature.
- ❖ They are optically active.
- ❖ They show mutarotation.
- ❖ They form glycosides by combining with methyl alcohol.



- ❖ They produce by esters by reacting with acetic anhydrides. (esterification) anhydrides.
- ❖ They are converted into ether groups upon treatment with methylating agents.

2. Oligosaccharides

- ❖ Oligosaccharides are formed of 2-to 10 monosaccharides. They have sweet taste. They are soluble in water.
- ❖ Oligosaccharides with 2 monosaccharide molecules are called disaccharides. (Eg) maltose.
- ❖ If they are formed of three monosaccharide they are called trisaccharides.
- ❖ Oligosaccharides are present in the cell membrane. They act as identifiers.
- ❖ They recognize immunoglobulin.
- ❖ The Oligosaccharides present in the cell wall of Nitrogen fixing bacteria help in binding the bacteria with the root hairs of leguminous plants.

3. Polysaccharides

- ❖ Polysaccharides are non sugars. They are not sweet.
- ❖ They are insoluble in water.
- ❖ They have high molecular weight.
- ❖ They may be homopolysaccharides or heteropolysaccharides.
- ❖ These are macromolecules.
- ❖ These are the energy storage products.
- ❖ For example in plants energy is stored in the form of starch.
- ❖ They are supportive in function. (Eg) cellulose in plants.
- ❖ They act as biological lubricants.
- ❖ Heteropolysaccharides act as biological cement.
- ❖ Heparin act as anticoagulant.

1.3.3 FUNCTIONS OF CARBOHYDRATES:

- 1) Carbohydrates form the structural components of cells. (eg) cellulose of plant cells.
- 2) Carbohydrates are the chief major constituents of immediate energy sources.(glucose)

MULTIPLE CHOICE QUESTIONS

- 1) Primate female reproductive cycle is called _____
 a) Menstrual cycle b) Water cycle c) Blood cycle d) Ovarian cycle
- 2) The first menstrual flow is called as _____
 a) Menopause b) Menstruation c) Menarche d) Ovulation
- 3) The onset of the menstrual cycle is characterized by a discharge of blood and tissue matter from the uterus. What is this discharge termed as?
 a) Egg b) Menarche c) Menses d) Ovulation
- 4) What layer of the uterus is shredded during menstruation?
 a) Perimetrium b) Myometrium c) Epimetrium d) Endometrium
- 5) Which of the following can lead to a menstrual cycle?
 a) Fertilization of egg b) Unfertilized egg c) Improper sleep d) Study pressure
- 6) Which of the following will not result in a miss in the menstrual cycle?
 a) Fertilization of the egg b) Anxiety and stress
 c) Bad health d) Gyming
- 7) The phase during which menses occur is called _____
 a) Primary phase b) Follicular phase c) Menstrual phase d) Luteal phase
- 8) The follicular phase is also called as _____
 a) Menstrual phase b) Luteal phase c) Proliferative phase d) Secretory phase
- 9) During what phase of menstrual cycle are primary follicles converted to Graafian follicles?
 a) Menstrual phase b) Follicular phase c) Luteal phase d) Secretory phase
- 10) Which of the following is not a function of sensory organs?
 a) Detect all the changes in the environment
 b) Send appropriate signals to CNS
 c) Analysis of signals
 d) Receive signals
- 11) In which of the following, olfactory receptors are present?
 a) Nose b) Eyes c) Throat d) Ears



- 12) The olfactory epithelium consists of how many cells?
a) One b) Two c) Three d) Four
- 13) The olfactory epithelium is the extension of which of the following?
a) Hypothalamus b) Pituitary gland c) Association areas d) Limbic system
- 14) Which of the following has the gustatory receptors?
a) Nose b) Tongue c) Eyes d) Skin
- 15) Where are our eyes located?
a) Zygomatic cavity b) Vomer cavity c) Orbits d) Sphenoid cavity
- 16) Which of the following layer forms the ciliary body?
a) Sclera b) Cornea c) Choroid layer d) Retina
- 17) The diameter of the pupil is regulated by which of the following?
a) Muscle fibres of the iris b) Sclera
c) Choroid layer d) Muscle fibres of the lens
- 18) How many layers of neural cells are present in the retina?
a) One b) Two c) Three d) Four
- 19) How many types of photoreceptor cells are present in the retina?
a) Two b) Three c) Four d) Five

MODEL QUESTIONS

- 1) Which of the following components are major nutrients in our food?
a) Carbohydrates
b) Lipids and Proteins
c) Vitamins and Minerals
d) All of the above
- 2) Which of the following food components is required for the growth and maintenance of the human body?
a) Proteins b) Vitamins c) Minerals d) Both (a) and (b)



- 3) Which of the following food components give energy to our body?
- a) Proteins b) Vitamins c) Minerals d) Carbohydrates
- 4) Which of the following food items provides dietary fibre?
- a) Pulses b) Wholegrain c) Fruits and vegetables d) All of the above
- 5) Which of the following food products are the best sources of animal proteins?
- a) Milk b) Egg c) Cheese d) All of the above.
- 6) Which of the following mineral functions by building strong bones and teeth?
- a) Iodine b) Calcium c) Iron d) Sodium
- 7) Egg is a rich source of _____.
- a) Proteins b) Vitamins c) Minerals d) All of the above
- 8) Which of the following food components does not provide any nutrients?
- a) Milk b) Water c) Fruit Juice d) Vegetable soup
- 9) Which of the following food items is the best source of plant proteins?
- a) Milk b) Egg c) Legumes d) Cheese
- 10) Which of the following food components is rich in fat?
- a) Rice and Maize b) Milk, egg and beans
c) Butter, cheese and oil d) None of the above
- 11) Which of the following statements is false about nutrients in milk?
- a) Milk is a good source of calcium b) Milk is a good source of protein
c) Milk is a good source of vitamin C d) Milk is a good source of vitamin D
- 12) Guava, Lemon, Orange and Tomato are rich in _____.
- a) vitamin A b) vitamin B c) vitamin C d) vitamin D
- 13) Potatoes, cereals, beans, pulses and oats are rich in _____.
- a) Proteins b) Vitamins c) Minerals d) Carbohydrates
- 14) Which of the following is not a component of food?
- a) Fats b) Fibres
c) Water d) None of the above



TEACHER'S CARE ACADEMY

38/23, Vaigundaperumal Koil Street, Kanchipuram-1

Mobile : 95665 35080, 97862 69980

Help Line Numbers : 9360268118,7639967359

UG TRB Zoology 2022-2023

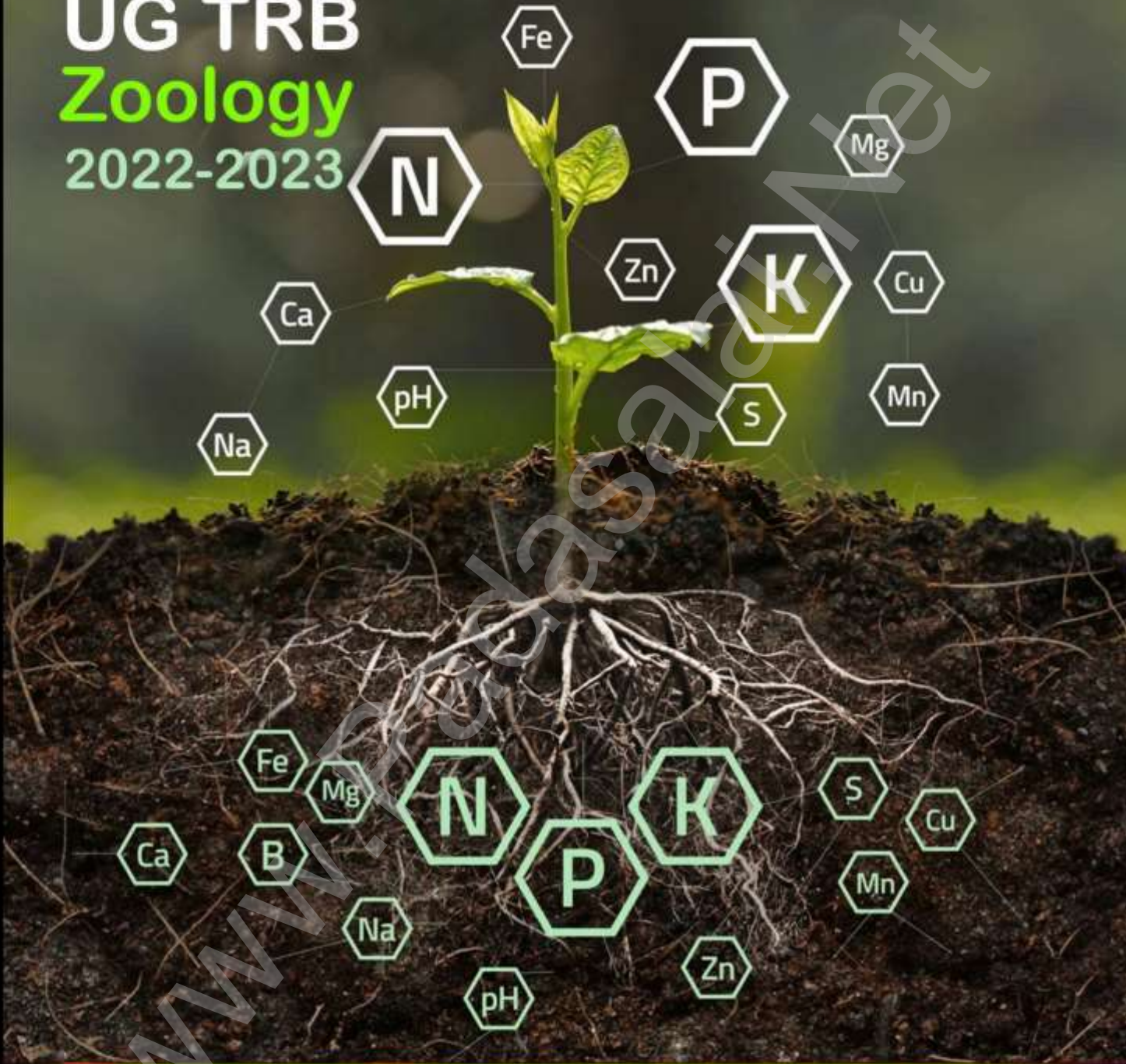

UNIT - VI

BIOCHEMISTRY & BIOTECHNOLOGY

Your Success is Our Goal....

TEACHER'S CARE ACADEMY KANCHIPURAM



ZOOLOGY

UNIT - 6

BIOCHEMISTRY AND BIOTECHNOLOGY



COMPETITIVE EXAM

FOR

UG -TRB-ZOOLOGY 2022 - 23

TEACHER'S CARE ACADEMY, KANCHIPURAM

TNPSC-TRB- COMPUTER SCIENCE -TET COACHING CENTER



**HEAD OFFICE: NO. 38/23, VAIGUNDA PERUMAL KOIL,
SANNATHI STREET, KANCHIPURAM – 1. CELL: 9566535080**

B.Off 2: 65C, Thillai Ngr (West), 4th Cross St, Trichy – 620018

B.Off 3: Vijayaraghavachariar Memorial Hall (Opp to Sundar Lodge), Salem

Trichy : 76399 67359

Salem : 93602 68118

UG TRB - 2022 - 2023

ZOOLOGY

UNIT - 6

BIOCHEMISTRY AND BIOTECHNOLOGY

SL.NO	CONTENTS		PAGE
1	Biological Properties and Classification of Carbohydrates		1
1.1	General Properties of Carbohydrates		1
1.2	Physical Properties of Carbohydrates		1
1.3	Biological Importance		1
1.4	Classification of Carbohydrates		2
	1.4.1	Monosaccharides	3
	1.4.2	Disaccharides	8
	1.4.3	Polysaccharides	11
2	Biological Properties and Classification of Proteins		18
2.1	Classification of Proteins		18
2.2	Chemicals Bonds Involved In Protein Structure		23
2.3	Structure of Proteins		24

	2.3.1	Primary Structure: Amino Acid Sequence	24
	2.3.2	Secondary Structure (or) Helix Forming (or) Local Folding:	24
	2.3.3	Tertiary Structure: Folding of The Chain or Overall Folding	26
	2.3.4	Quaternary Structure: Protein-Protein Interaction (or) Multi Chain Association	26
2.4	Denaturation of Proteins		27
3	Biological Properties And Classification of Lipids or Fats		29
3.1	Introduction		29
3.2	Definition		29
3.3	Occurrence		29
3.4	Food Sources Rich In Fat Are		29
3.5	Classification Of Lipids		30
	3.5.1	Simple Lipids	30
	3.5.2	Compound Lipids	31
	3.5.3	Derived Lipids	33
3.6	Physical And Chemical Properties of Lipids		35
	3.6.1	Physical Properties of Lipids	35
	3.6.2	Chemical Properties of Lipids	35
3.7	Characterization and Identification of Fatty Acids		36
	3.7.1	Physical Method	36
	3.7.2	Chemical Method	36
3.8	Fatty Acids		37
	3.8.1	Structure	37

	3.8.2	Classification of Fatty Acids	37
4	Carbohydrate, Protein and Lipid Metabolism		40
4.1	Carbohydrate Metabolism		40
	4.1.1	Glycolysis (Embden-Meyerhof pathway)	40
	4.1.2	Glycogenolysis	43
	4.1.3	Gluconeogenesis	45
	4.1.4	Glycogenesis	47
	4.1.5	Citric Acid Cycle:(Kreb's cycle)	49
	4.1.6	Oxidative Phosphorylation	51
	4.1.7	Electron Transport Chain	52
4.2	Lipid Metabolism		60
	4.2.1	Biosynthesis of Saturated Fattyacids	60
	4.2.2	Location	61
	4.2.3	Significance	63
	4.2.4	Unsaturated Fatty Acids Definition	63
	4.2.5	Beta-Oxidation of Fatty Acid	64
	4.2.6	Overall Reaction of Beta Oxidation	69
	4.2.7	Regulation Of Beta-Oxidation Of Fatty Acids	69
	4.2.8	Omega Oxidation (Ω -Oxidation) of Fatty Acid	72
	4.2.9	Biosynthesis of Cholesterol:	75
	4.2.10	Biosynthesis of triglycerides (Tag)	78
	4.2.11	Metabolism of Ketone Bodies	79
4.3	Protein Metabolism		82

	4.3.1	Aminoacid Pool	82
	4.3.2	Digestion of Dietary Proteins	82
	4.3.3	Transport of Aminoacids Into Cells	84
	4.3.4	Nitrogen Metabolism -Removal of Nitrogen From Aminoacids	85
5	Deamination And Transamination		91
5.1	Deamination		91
	5.1.1	Oxidative Deamination	91
5.2	Transamination		92
6	Fate of Keto ACIDS		98
7	BMI And BMR		101
7.1	Definition of BMR		101
7.2	Factors Influencing BMR		101
7.3	Significance of BMR		103
7.4	What is the full form of BMI?		103
7.5	Calculation Method of BMI		104
7.6	Importance of BMI		104
7.7	Values of BMI		104
8	Biotechnology		107
8.1	Scope And Importance		107
8.2	Application of Biotechnology		110
9	Recombinant DNA (r DNA) Technology		119
9.1	History & Recent Developments In r DNA		120
9.2	Application of Genetic Recombinant Technology In Health Care		122

9.3	Agriculture Application		124
	9.3.1	Application of Transgenic Plants	125
	9.3.2	Delayed Fruit Ripening	129
	9.3.3	Male Sterility	129
10	Genetic Engineering		131
10.1	Enzymes In Rdna Technology		131
10.2	Nucleases		132
10.3	Restriction Enzymes or Restriction Endonucleases		132
	10.3.1	History of Restriction Enzymes	132
	10.3.2	Types of Restriction Enzymes And Properties:	133
	10.3.3	Nomenclature of Restriction Enzymes	133
	10.3.4	Mechanism And Action of Restriction Enzymes	134
10.4	Ligases		138
	10.4.1	Types And Mechanism of Dna Ligase:	138
	10.4.2	Applications of Ligase Activity	139
	10.4.3	Elongation or Circularization of Dsdna	139
	10.4.4	Synthesis of Long Rna Molecules	139
10.5	Linkers		140
10.6	Adaptors		141
10.7	DNA Polymerases		141
	10.7.1	E. Coli Dna Polymerase I	142
	10.7.2	T ₄ DNA Polymerase	143
	10.7.3	T ₇ DNA Polymerase	144

	10.7.4	Taq DNA Polymerase	144
	10.7.5	Reverse Transcriptase	145
	10.7.6	RNases or RNA Nucleases	146
	10.7.7	Ribonuclease	146
11	Polymerase Chain Reaction (Pcr) And Its Applications		148
11.1	Basic Protocol For Polymerase Chain Reaction		148
	11.1.1	Components And Reagents	148
	11.1.2	Procedure	148
	11.1.3	Applications	152
11.2	Variations In PCR		152
	11.2.1	Reverse Transcription PCR (RT-PCR)	152
	11.2.2	Real Time PCR or Quantitative PCR (qPCR)	153
	11.2.3	Hot Start PCR:	153
	11.2.4	Nested PCR	155
	11.2.5	Touchdown PCR	156
	11.2.6	Inverse PCR	156
	11.2.7	Multiplex PCR	157
12	Gene Cloning		162
12.1	Introduction		162
12.2	Steps Involved In Gene Cloning		162
13	Vector and Plasmid		165
13.1	Vectors		165
	13.1.1	cloning Vector	166

	13.1.2	Expression Vector	166
13.2	Plasmids and Its Properties		166
	13.2.1	Properties of Plasmid	167
	13.2.2	Replication of Plasmids	167
	13.2.3	Size of Plasmids	167
	13.2.4	Amplification of The Plasmid	167
13.3	Types of Plasmids		168
13.4	Plasmid pBR322		168
	13.4.1	Nomenclature.	169
	13.4.2	Origin of pBR322	169
	13.4.3	Advantages of pBR322	169
	13.4.4	Disadvantages of Plasmid pBR322	170
13.5	pUC 118 and pUC 119		170
13.6	Bacteriophage Vectors For E.Coli		173
	13.6.1	Phage Lambda As A Vector	173
13.7	Filamentous Phages As Cloning Vector		174
	13.7.1	M13 Bacteriophage.	174
13.8	Cosmids		175
13.9	Shuttle Vector		176
13.10	Expression Vector		177
13.11	Types of Expression Vectors:		178
14	Construction of a cDNA Library		184
14.1	Isolation of mRNA		184

14.2	Synthesis of First And Second Strand of cDNA		185
14.3	Incorporation of cDNA Into a Vector		186
14.4	Cloning of cDNA		187
14.5	Applications of cDNA Libraries/Cloning		188
14.6	Disadvantages of cDNA Libraries		188
15	Genomic Library		191
15.1	Mechanisms For Cleaving DNA		191
16	Gene Bank		196
16.1	Structure of Genbank Entries		197
17	Production of Biotechnological Products		200
17.1	Single Cell Protein-SCP		200
	17.1.1	Production of SCP	200
	17.1.2	Applications	202
17.2	Biofertilizers		203
	17.2.1	Preparation of a Biofertilizer	204
17.3	Biopesticides		210
	17.3.1	Bacillus Thuringiensis	210
	17.3.2	Fungal Pesticides	212
17.4	Biogas		214
	17.4.1	Properties of Biogas	214
	17.4.2	Composition of Biogas	214
	17.4.3	Microbiology of Biogas Production:	215
	17.4.4	Biogas Plant and Its Components:	216

	17.4.5	Classification of Biogas Plants	217
	17.4.6	Floating Drum Type (Constant Pressure)	218
	17.4.7	Fixed Dome Biogas Plants (Constant Volume)	218
	17.4.8	Janatha Biogas Plants	219
	17.4.9	Deenbandhu Biogas Plants	219
	17.4.10	Factors Involved In Biogas Production	220
	17.4.11	Uses of Biogas	222
17.5	Biofuel Technology		227
	17.5.1	Biological Carbon Fixation	227
	17.5.2	Bioethanol And Biodiesel Production	227
	17.5.3	Jatropha Curcas Used For The Production Of Biodiesel	229
18	Solid And Liquid Waste Management		232
18.1	Solid Waste Management		232
	18.1.1	Organic Waste Recycling	233
	18.1.2	Methods of Organic Waste Recycling	234
	18.1.3	Process (General Steps / Mechanism) of Organic Waste Recycling	237
	18.1.4	Significance of Organic Waste Recycling	238
	18.1.5	Barriers And Challenges of Organic Waste Recycling	238
18.2	Liquid Waste Management		239
	18.2.1	Treatment And Management of Liquid Waste	239
	18.2.2	Management of Liquid Waste Through Sewage Treatment:	240

	18.2.3	Use of Algae And Aquatic Macrophytes For The Management of Waste Liquid:	241
19	Enzyme Biotechnology-Sources And Production Of Commercially Important Enzymes		245
19.1	Amylase (Enzyme)		245
	19.1.1	Enzymes From Animal And Plant Sources	245
	19.1.2	Enzymes From Microbial Sources	246
	19.1.3	Production	246
19.2	Proteases		248
19.3	Pectinases		250
19.4	Cellulases		250
	19.4.1	Fermentation Production	251
	19.4.2	Cellulase Production	251
		MORE IMPORTANT QUESTION (127)	254

UNIT VI

BIOCHEMISTRY AND BIOTECHNOLOGY

1. BIOLOGICAL PROPERTIES AND CLASSIFICATION OF CARBOHYDRATES

- Carbohydrates are the most abundant biomolecules on earth. Oxidation of carbohydrates is the central energy-yielding pathway in most non-photosynthetic cells.
- Definition: Carbohydrates are polyhydroxy aldehydes or ketones, or substances that yield such compounds on hydrolysis.
- carbohydrates have the empirical formula $(CH_2O)_n$.

1.1 GENERAL PROPERTIES OF CARBOHYDRATES

- Carbohydrates act as energy reserves, also stores fuels, and metabolic intermediates.
- Ribose and deoxyribose sugars forms the structural frame of the genetic material, RNA and DNA.
- Polysaccharides like cellulose are the structural elements in the cell walls of bacteria and plants.
- Carbohydrates are linked to proteins and lipids that play important roles in cell interactions.
- Carbohydrates are organic compounds, they are aldehydes or ketones with many hydroxyl groups.

1.2 PHYSICAL PROPERTIES OF CARBOHYDRATES

- Stereoisomerism - Compound having same structural formula but they differ in spatial configuration. Example: Glucose has two isomers with respect to penultimate carbon atom. They are D-glucose and L-glucose.
- Optical Activity - It is the rotation of plane polarized light forming (+) glucose and (-) glucose.
- Diastereoisomers - It the configurational changes with regard to C2, C3, or C4 in glucose. Example: Mannose, galactose.
- Anomerism - It is the spatial configuration with respect to the first carbon atom in aldoses and second carbon atom in ketoses.

1.3 BIOLOGICAL IMPORTANCE

- Carbohydrates are chief energy source, in many animals, they are instant source of energy. Glucose is broken down by glycolysis/ kreb's cycle to yield ATP.
- Glucose is the source of storage of energy. It is stored as glycogen in animals and starch in plants.
- Stored carbohydrates acts as energy source instead of proteins.

- Carbohydrates are intermediates in biosynthesis of fats and proteins.
- Carbohydrates aid in regulation of nerve tissue and is the energy source for brain.
- Carbohydrates gets associated with lipids and proteins to form surface antigens, receptor molecules, vitamins and antibiotics.
- They form structural and protective components, like in cell wall of plants and microorganisms.
- In animals they are important constituent of connective tissues.
- They participate in biological transport, cell-cell communication and activation of growth factors.
- Carbohydrates that are rich in fibre content help to prevent constipation.
- Also they help in modulation of immune system.

1.4 CLASSIFICATION OF CARBOHYDRATES

There are three major classes of carbohydrates:

1. Monosaccharides

- Monosaccharides, or simple sugars, consist of a single polyhydroxy aldehyde or ketone unit. The most abundant monosaccharide in nature is the six-carbon sugar D-glucose, sometimes referred to as dextrose.

2. Oligosaccharides

- Oligosaccharides consist of short chains of monosaccharide units, or residues, joined by characteristic linkages called glycosidic bonds. The most abundant are the disaccharides, with two monosaccharide units. Example: sucrose (cane sugar).

3. Polysaccharides

- The polysaccharides are sugar polymers containing more than 20 or so monosaccharide units, and some have hundreds or thousands of units. Example: starch.
- Polysaccharides are of two types based on their function and composition. Based on function, polysaccharides of two types storage and structural.
 - A. Storage polysaccharide - starch.
 - B. Structural polysaccharide - cellulose.

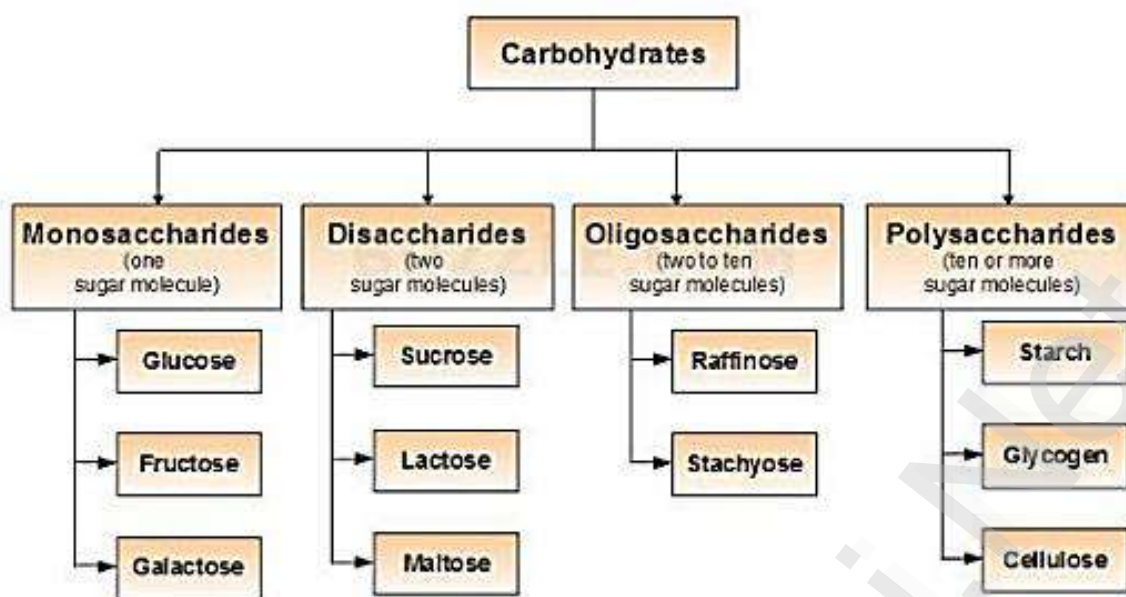

1.4.1. MONOSACCHARIDES

The word “Monosaccharides” derived from the Greek word “Mono” means Single and “saccharide” means sugar

- Monosaccharides are polyhydroxy aldehydes or ketones which cannot be further hydrolysed to simple sugar.
- Monosaccharides are simple sugars. They are sweet in taste. They are soluble in water. They are crystalline in nature.
- They contain 3 to 10 carbon atoms, 2 or more hydroxyl (OH) groups and one aldehyde (CHO) or one ketone (CO) group.

1.4.1.1. Classification of Monosaccharides

- Monosaccharides are classified in two ways. (a) First of all, based on the number of carbon atoms present in them and (b) secondly based on the presence of carbonyl group.
- The naturally occurring monosaccharides contain three to seven carbon atoms per molecule. Monosaccharides of specific sizes may be indicated by names composed of a stem denoting the number of carbon atoms and the suffix -ose. For example, the terms triose, tetrose, pentose, and hexose signify monosaccharides with, respectively, three, four, five, and six carbon atoms. Monosaccharides are also classified as aldoses or ketoses. Those monosaccharides that contain an aldehyde functional group are called aldoses; those containing a ketone functional group on the second carbon atom are ketoses. Combining these classification systems gives general names that indicate both the type of carbonyl group and the number of carbon atoms in a molecule. Thus, monosaccharides are described as aldotetroses, aldopentoses, ketopentoses, ketoheptoses, and so forth. Glucose and fructose are specific examples of an aldohexose and a ketohexose, respectively.

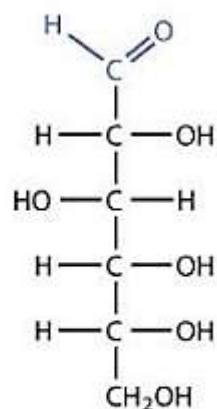

Glucose
(an aldohexose)

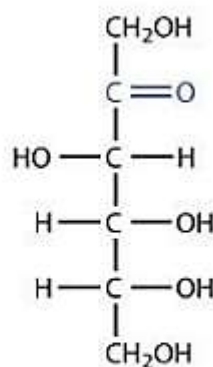

Fructose
(a ketohexose)

Name	Formula	Aldose	Ketose
Triose	$\text{C}_3\text{H}_6\text{O}_3$	Glycerose	Dihydroxy acetone
Tetrose	$\text{C}_4\text{H}_8\text{O}_4$	Erythrose	Erythrulose
Pentose	$\text{C}_5\text{H}_{10}\text{O}_5$	Ribose	Ribulose
Hexose	$\text{C}_6\text{H}_{12}\text{O}_6$	Glucose	Fructose
Heptose	$\text{C}_7\text{H}_{14}\text{O}_7$	Glucoheptose	Sedo heptulose

1. Trioses

- Trioses are “Monosaccharides” containing 3 carbon atoms. The molecular formula of triose is $\text{C}_3\text{H}_6\text{O}_3$

Characteristics

- Trioses are simple sugars
- They are soluble in water
- They are sweet in taste.
- The triose may contain an aldehyde group (aldotriose) or a ketone group (ketotriose).

Example Glycerose and Dihydroxyacetone

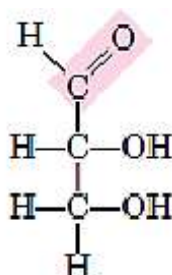

Glyceraldehyde,
an aldotriose

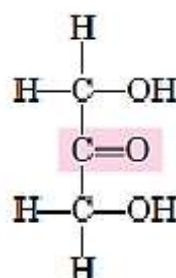

Dihydroxyacetone,
a ketotriose

2.Tetroses

- Tetroses are “Monosaccharides” containing 4 carbon atoms. The molecular formula of tetrose is C₄H₈O₄

Characteristics

- Tetroses are simple sugars
- Tetroses are soluble in water
- They are sweet in taste .
- They are crystalline forms.
- The tetroses may contain an aldehyde group (aldotetrose) or a ketone group (ketotetrose).

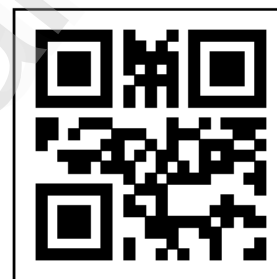
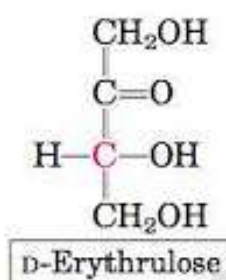
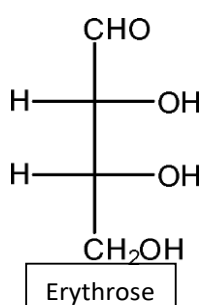

3.Pentoses

- Pentoses are “Monosaccharides” containing 5 carbon atoms. It is an important component of “nucleic acid”. The molecular formula of Pentose is C₅H₁₀O₅

Characteristics

- Pentoses are simple sugars
- Pentoses are soluble in water
- They are sweet in taste .
- They are crystalline forms.
- The pentoses may contain an aldehyde group (aldopentose) group or a ketone (ketopentose).

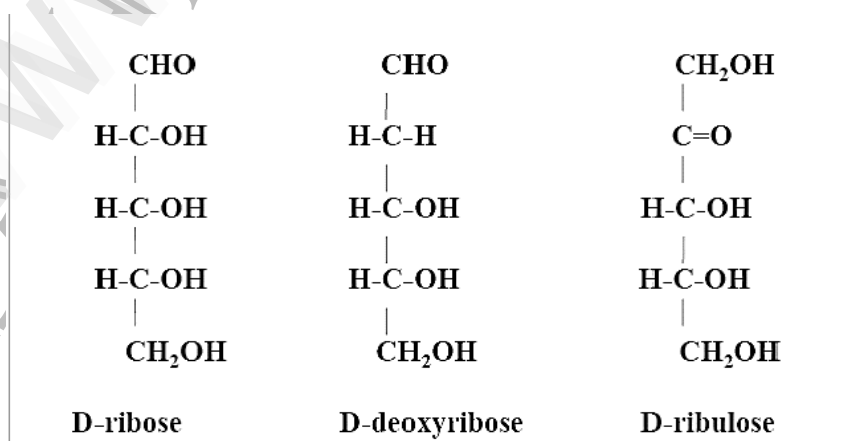

4. Hexoses

- Hexoses are “Monosaccharides” containing 6 carbon atoms. The molecular formula of Hexose is $C_6H_{12}O_6$

Characteristics

- Hexoses are simple sugars
- Hexoses are soluble in water
- They are sweet in taste.
- They are crystalline forms.
- The pentoses may contain an aldehyde group (aldohexose) or a ketone group (ketohehexose).

1.4.1.2 Structure of Monosaccharides

1. **Straight or Open Chain Structure:** Here 6 carbon atoms of glucose are arranged in a straight line. It is also called open chain structure because the two ends remain separate and they are not linked. Open chain structure are of two types –

(a) Structure proposed by Fittig and Baeyer

(b) Structure proposed by Fischer known as Fischer’s Projection Formula.

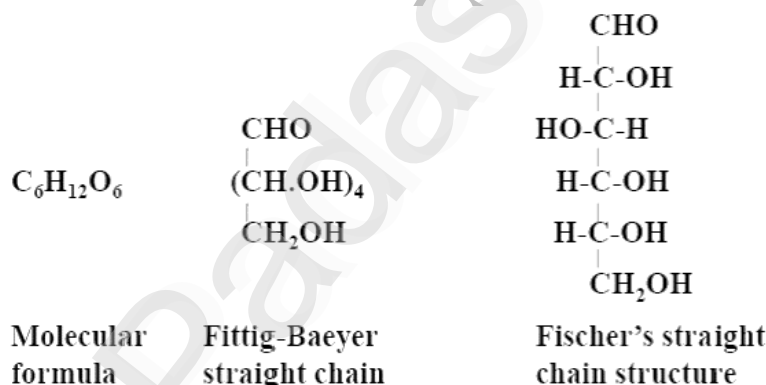

2. **Cyclic or Ring Structure:** Here the atoms are arranged in the form of a ring. Haworth (1929) proposed this formula and hence the name Haworth’s Projection Formula. The sugar molecules exist in two type of rings which are as follows –

(a) Furanose Ring – 5 membered ring

(b) Pyranose Ring- 6 membered ring

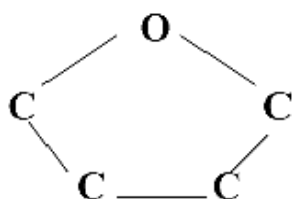

Furanose Ring

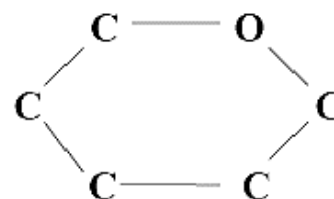

Pyranose Ring

1.4.1.3 Properties of Monosaccharides

- **Colour** - colourless
- **Shape** - crystalline
- **Solubility** – water soluble
- **Taste** - sweet
- **Optical activity** – Optically active. (a) Dextrorotatory ('d' form) and (b) Levorotatory ('l' form)
- **Mutarotation** – The change in specific rotation of an optically active compound is called mutarotation. +1120 +52.50 +190 α -D-glucose β -D-glucose
- **Glucoside formation** –

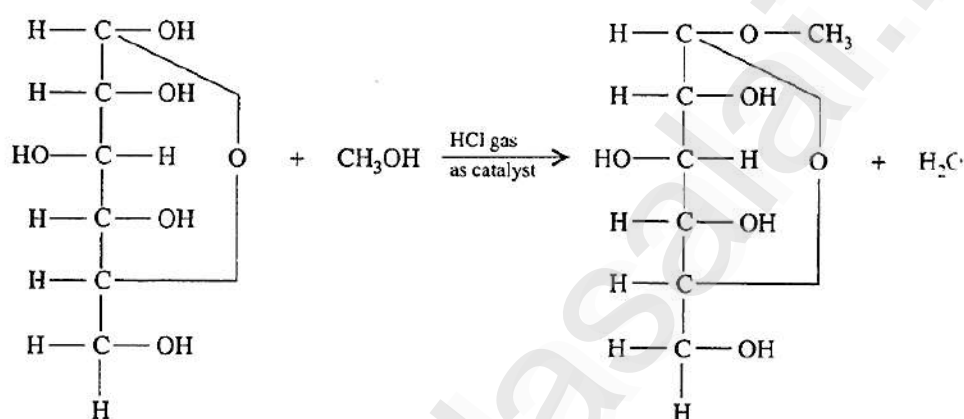

Glucose + Methyl alcohol = Methyl glucoside

- **Esterification** –

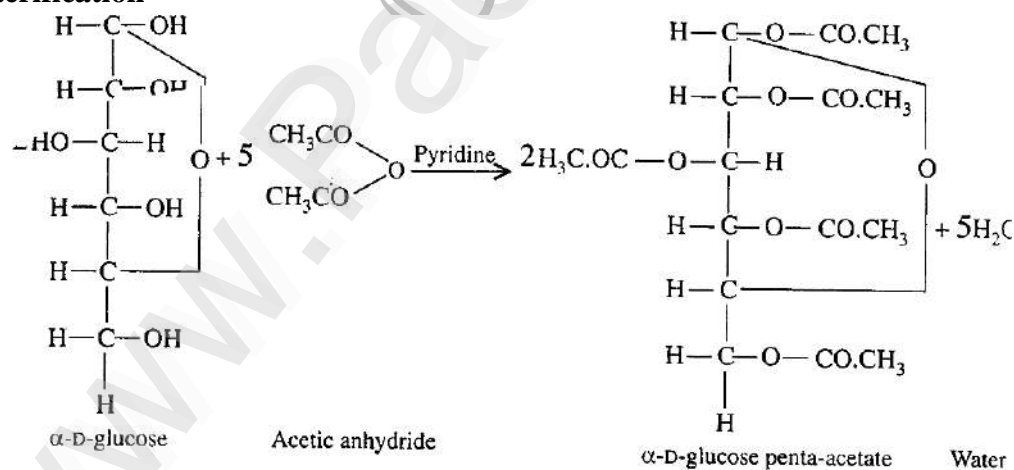

- **Reducing agents** –

- Monosaccharides reduce oxidizing agent such as hydrogen peroxide. In such reaction, sugar is oxidized at the carbonyl group and oxidizing agent becomes reduced.
- $C_6H_{12}O_6 + 2 Cu(OH)_2 \rightarrow C_6H_{12}O_7 + Cu_2O + 2H_2O$
- Glucose Fehling's solution
- Gluconic acid
- Cuprous oxide

➤ **Formation of Osazone –**

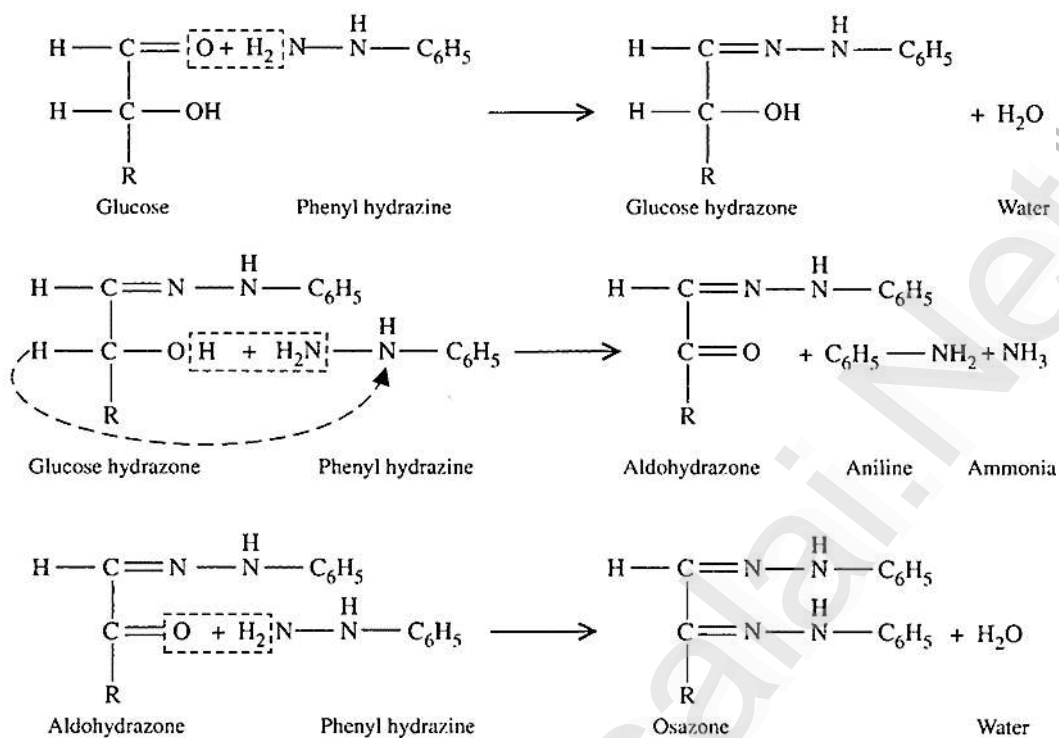

1.4.2 DISACCHARIDES

- Disaccharides consist of two sugars joined by an O-glycosidic bond. The most abundant disaccharides are sucrose, lactose and maltose. Other disaccharides include isomaltose, cellobiose and trehalose.

The disaccharides can be classified into:

1. Homodisaccharides
2. Heterodisaccharides.

Hommodisaccharides	Maltose (malt sugar)	Isomaltose	Celebiose
structure	2 α -glucose	2 α -glucose	2 β -D-glucose
Type of bond	α 1-4 glucosidicbond	α 1-6 glucosidicbond	β 1-4 glucosidicbond.
Anomeric Carbon	Free	Free	Free
Reducing Property	Reducing	Reducing	Reducing
Produced by	It is produced from starch by the action of amylase	by the hydrolysis of some polysaccharides such as dextran	by the acid hydrolysis of cellulose

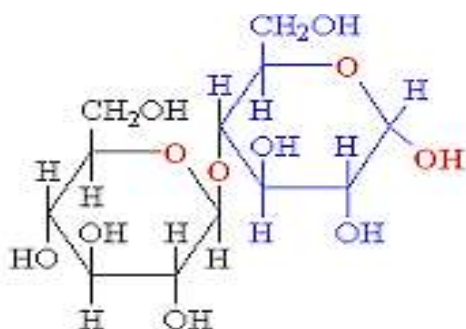
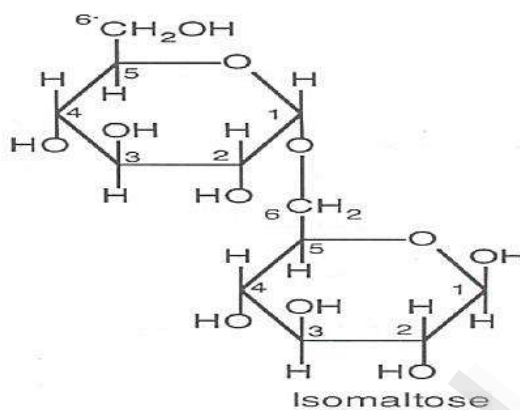
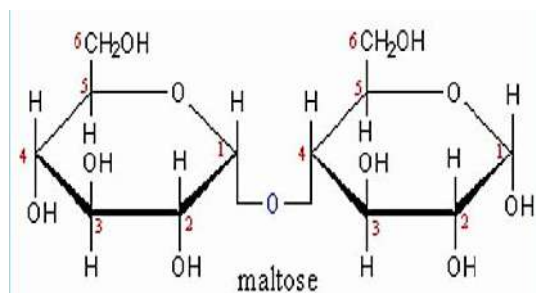

4-(β -D-glucopyranosyl)-D-glucose



Heterodisaccharides: are formed of 2 different monosaccharide units

Heterodisaccharides	Sucrose	Lactose
Composition	α -D-glucose+ β -D-fructose	β -D-galactoseand β -D-glucose
Type of bond	α -1- β -2 glucosidic bond OR β 2- α -1 fructosidic bond	a β (1 \square 4) galactosidicbond
AnomericC	no free aldehydeor ketonegroup	free
Reducing property	is not a reducing sugar	Reducing
Composition	α -D-glucose+ β -D-fructose	β -D-galactoseand β -D-glucose
AnomericC	nofreealdehydeorketonegroup	free
Effectofhydrolysis	The hydrolysis of sucrose to glucose and fructose is catalysed by sucrose (also called invertase),	Hydrolysed by the intestinal lactase enzyme into galactose and glucose
Present in	Table sugar Cane sugar, beet sugar	Milk sugar It may appear in urine in late pregnancy and during lactation

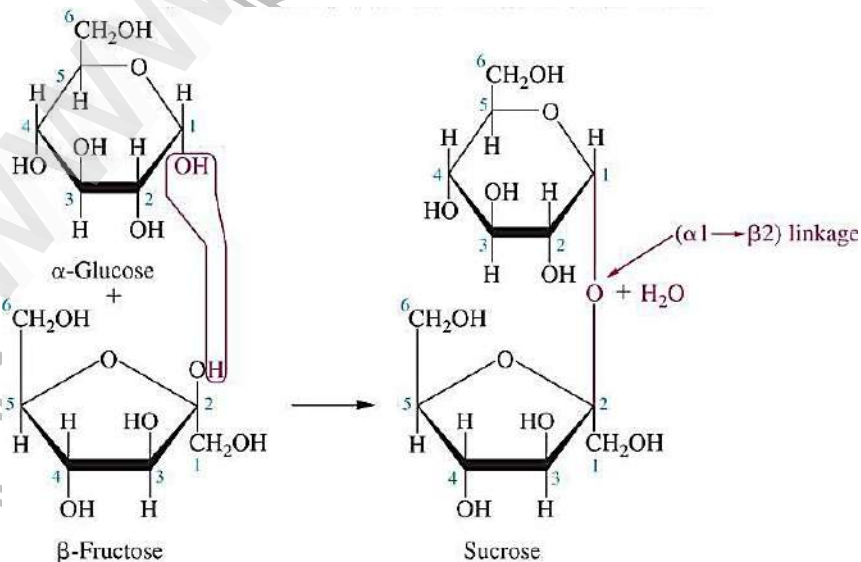
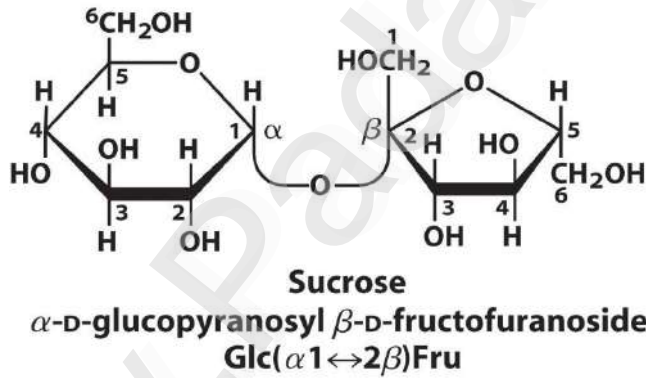
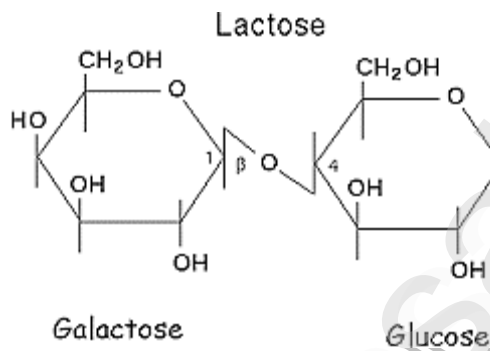
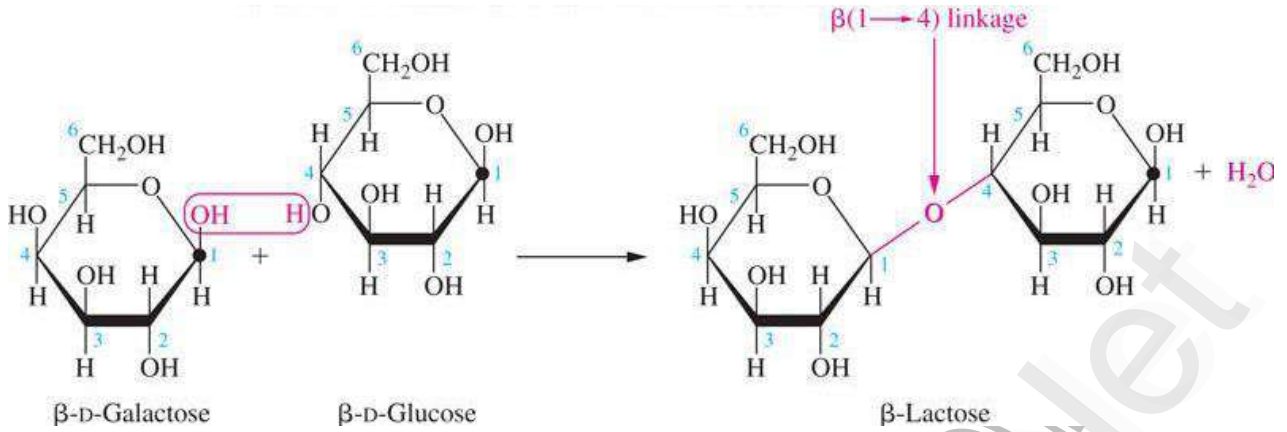

1.4.3 POLYSACCHARIDES

Polysaccharides contain hundreds or thousands of carbohydrate units.

- Polysaccharides are not reducing sugars, since the anomeric carbons are connected through glycosidic linkages.
- Nomenclature:

Homopolysaccharide- a polysaccharide is made up of one type of monosaccharide unit

Heteropolysaccharide- a polysaccharide is made up of more than one type of monosaccharide unit

1. Starch

- Starch is a polymer consisting of D-glucose units.
- Starches (and other glucose polymers) are usually insoluble in water because of the high molecular weight, but they can form thick colloidal suspensions with water.
- Starch is a storage compound in plants, and made of glucose units
- It is a homopolysaccharide made up of two components: amylose and amylopectin.
- Most starch is 10-30% amylose and 70-90% amylopectin.
- Amylose – a straight chain structure formed by 1,4 glycosidic bonds between α -D-glucose molecules.

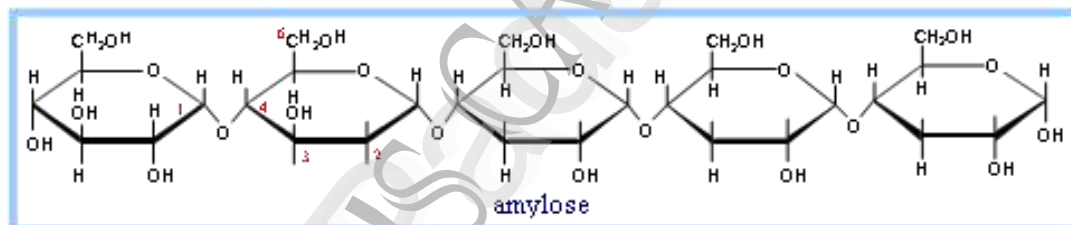

Structure of Amylose Fraction of Starch

- The amylose chain forms a helix.
- This causes the blue colour change on reaction with iodine.
- Amylose is poorly soluble in water, but forms micellar suspensions
- Amylopectin-a glucose polymer with mainly α -(1 \rightarrow 4) linkages, but it also has branches formed by α -(1 \rightarrow 6) linkages. Branches are generally longer than shown above.

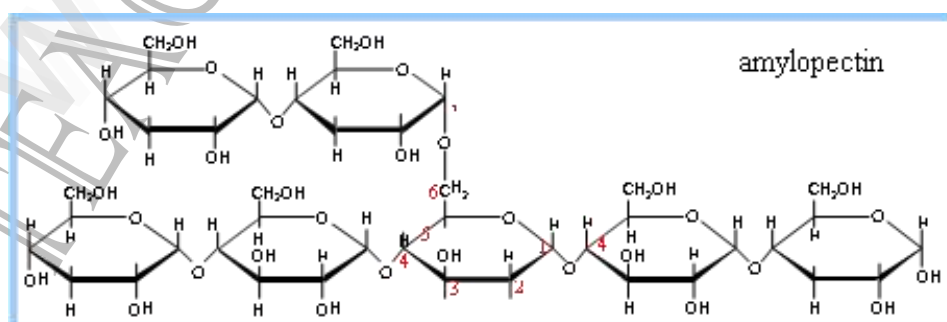

Structure of Amylopectin Fraction of Starch

CHAPTER 19 QUESTIONS

1. Which of the following does not produce "Proteases"?
 - a) Bacillus
 - b) Rhizopus
 - c) Mucor
 - d) Bacillus coagulans
2. Cellulase is used in which type of industry?
 - a) Food industry
 - b) Paper industry
 - c) Biofuel industry
 - d) Chemical industry
3. Which of the following is not included in immobilization process?
 - a) Absorption
 - b) Adsorption
 - c) Entrapment
 - d) Affinity
4. Which of the following is not included in immobilization process?
 - a) Absorption
 - b) Adsorption
 - c) Entrapment
 - d) Affinity
5. Which of the following is not an upstream process?
 - a) Selection of a suitable enzyme
 - b) Process development
 - c) Concentration and primary purification of enzymes
 - d) Large scale production
6. Which of the following purified enzyme is used in pharmaceutical industry?
 - a) Subtilisin
 - b) Novozym-435
 - c) Bromelain
 - d) Asparaginase
7. Which type of fermentation is used for large scale manufacturing of enzymes?
 - a) Solid-state fermentation
 - b) Submerged fermentation
 - c) Solid-Gas state fermentation
 - d) Gas-state fermentation
8. Which enzyme was first produced industrially?
 - a) Bacteria enzyme
 - b) Yeast enzyme
 - c) Fungal enzyme
 - d) Streptomyces
9. The production of enzyme is mostly carried out by?
 - a) Batch fermentation
 - b) Continuous fermentation
 - c) Fed-batch fermentation
 - d) Semi-batch fermentation



10. What do you mean by "Nutrient repression"?

- a) Inhibition of unwanted enzyme production
- b) Production of unwanted enzymes
- c) Inhibition of cell nutrients
- d) Production of waste

UNIT-6 QUESTIONS

1. Carbohydrates are also known as _____

- (a) Hydrates of carbon
- (b) Carbonates
- (c) Glycolipids
- (d) Polysaccharides

2. Class of carbohydrate which cannot be hydrolyzed further, is known as?

- (a) Disaccharides
- (b) Polysaccharides
- (c) Proteoglycan
- (d) Monosaccharide

3. Which class of carbohydrates is considered as non-sugar?

- (a) Monosaccharides
- (b) Disaccharides
- (c) Polysaccharides
- (d) Oligosaccharides

4. A molecule of amylopectin which contains 1500 glucose residues and is branched after every 30 residues. How many reducing ends are there?

- (a) 0
- (b) 1
- (c) 2
- (d) 5

5. What is the name of the drug which inhibits Na^+/K^+ pump across the cell membrane?

- (a) Taxol
- (b) Vinblastine
- (c) Quinone
- (d) Ouabain

6. Mark the INCORRECT statement about sugar alcohol?

- (a) Addition of -itol as a suffix
- (b) A linear molecule that cannot cyclize
- (c) Carbonyl groups reduced to a hydroxyl group
- (d) Terminal -OH group oxidizes

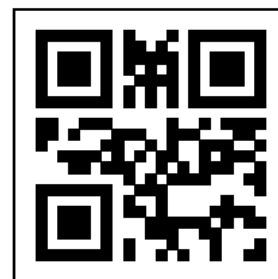

7. Which of the following amino sugar are present in the bacterial cell wall?
- (a) N-acetylmuramic acid (b) Sialic acid
(c) Aminoglycoside (d) Azide
8. Which of the following glycosidic linkage found in maltose?
- (a) Glucose (α -1 – 2 β) Fructose (b) Glucose (α 1 – 4) Glucose
(c) Galactose (β 1 – 4) Glucose (d) Glucose (β 1 – 4) Glucose
9. Which of the following is also known as invert sugar?
- (a) Sucrose (b) Fructose (c) Dextrose (d) Glucose
10. Name the major storage form of carbohydrates in animals?
- (a) Cellulose (b) Chitin (c) Glycogen (d) Starch
11. The general structure of all amino acids are same except for _____
- (a) Lysine (b) Glycine (c) Proline (d) Alanine
12. Which of these amino acids are not optically active?
- (a) Cysteine (b) Lysine (c) Arginine (d) Glycine
13. Which of these are used to measure optical activity?
- (a) Polarimeter (b) Planometer (c) Psychrometer (d) Photometer
14. Name the amino acid, which exists in two non-superimposable mirror images of each other.
- (a) Epimer (b) Anomer (c) Enantiomer (d) Chiral carbon
15. Which of these are rare amino acid in a protein?
- (a) Leucine and serine (b) Lysine and glutamic acid
(c) Tryptophan and methionine (d) Leucine and lysine
16. In which amino acid Imidazole group, an aromatic ring found?
- (a) Lysine (b) Arginine (c) Histidine (d) Glutamate
17. What is the maximum wavelength that Tryptophan and tyrosine absorb?
- (a) 280nm (b) 260nm (c) 257nm (d) 230nm
18. How is the secondary structure of a protein stabilized?
- (a) Van der wall forces (b) Hydrogen bonding
(c) Covalent bond (d) Hydrophobic bond

For more details Contact

Online Class for
UG TRB
Started

UG TRB (2022-2023)

9566535080, 9360268118
7639967359

All 10 Units

Website
www.tcaexamguide.com

Mobile App
tcaexamguide

Experienced
professors
&
Any time any where
access to class

Multiple time
can be watched
&
Access from
Mobile app
and Website

Teachers care Academy is the foremost coaching Institution for various competitive examinations such as P.G.TRB, TET Papers I &II TNPSC including special Teachers Eligibility Test. The Academy was established on 5th April 2013 by learned energetic and multifaceted chairperson Mrs. RAVIMAGESHWARI in the holy temple town of Kanchipuram.

Our Other Competitive Exam. Guides

- ❖ PG-TRB (Tamil, English, Mathematics, History, Physics, Chemistry, Commerce, Economics, Botany, Zoology)
- ❖ Polytechnic-TRB (English, Mathematics, Physics, Chemistry, CSE, ECE, Civil, EEE, Mech)
- ❖ Computer Instructor Grade-1
- ❖ Block Educational Officer
- ❖ Teachers Eligibility Test (TET Paper-1 & Paper-2) & UG-TRB
- ❖ TNEB – Assessor
- ❖ Tamil Nadu – Forest Guard
- ❖ TNPSC (Group-1, Group-2, Group-3, Group-4)
- ❖ NEET

Your Success is Our Goal....



Teachers Care Academy



tcaexamguide



tcaexamguide@gmail.com



www.tcaexamguide.com



Teachers Care Publication

38/23, Vaigundaperumal Koil Street, Kanchipuram-1

Mobile : 95665 35080, 97862 69980

Help Line Numbers : 9360268118 7639967359

1st

Edition

Kindly Send me your Answer Keys to email id - Padasalai.net@gmail.com